



# ESD and CLEANROOM

# GARMENTS

REV: 2022.11



# ESD REQUIRMENTS







ACCORDING TO IEC 61340-4-9:2016

Common industry description/Use of garment system:	Garment type:	Test procedure:	Specific Resistance values:
Garments with some electrical field suppression properties	Static control garment	Resistance point to point	$< 1,0 \times 10^{11} \Omega$
Garments with a designated groundable point	Groundable static control garment	Resistance point to point and resistance point to groundable point	$< 1,0 \times 10^9 \Omega$
Garment in continuous electrical path with a person; however, not the primary ground path	Groundable static control garment	Resistance point to point and resistance point to groundable point	$< 1,0 \times 10^9 \Omega$
Grounded with dual paths to ground via continuous monitoring equipment that requires two separate paths to ground	Groundable static control garment system (garment in combination with person)	Resistance point to point and resistance point to groundable point	$< 1,0 \times 10^9 \Omega$
		Integrated wrist strap in accordance with IEC 61340-4-6	$< 3,5 \times 10^7 \Omega$
Grounded through a single wire constant monitor system	Groundable static control garment system (garment in combination with person)	Resistance point to point and resistance point to groundable point	$< 1,0 \times 10^9 \Omega$
		Integrated wrist strap in accordance with IEC 61340-4-6	$< 3,5 \times 10^7 \Omega$
Garment used as primary grounding path for personnel	Groundable static control garment system (Garment in combination with person)	Resistance point to point and resistance point to groundable point	$< 1,0 \times 10^9 \Omega$
		Integrated wrist strap in accordance with IEC 61340-4-6	$< 3,5 \times 10^7 \Omega$

**!** Our ESD clothing products meet the above requirements!  
 In case of groundable **static control** garment, the additional order code is **GND**



# ESD FABRICS

Type	KK01	TH55	CT35	TH65	CR10	CR10HI	TS15	TS16	PS21	LY20	FL1	WC10	THSS	THSB
Material	Woven	Woven	Woven	Woven	Woven (cleanroom)	Woven (cleanroom)	Knitted	Knitted (Pique)	Knitted	Knitted	Fleece	Woven (water repellent)	Knitted	Knitted (Fluffy)
Polyester (%)	74	63	69	36	98	98	-	-	47	-	96	98	48	48
Cotton (%)	24	33	27	60	-	-	96	96	50	88	-	-	48	48
Conductive fibre (%)	2	4	4	4	2	2	4	4	3	4	4	2	4	4
Lycra (%)	-	-	-	-	-	-	-	-	-	8	-	-	-	-
Weight (g/m <sup>2</sup> )	125	155	130	160	110	125	150	210	210	200	280	120	280	320
Colour														
Page	14	15	15	15	16	16	17	17	18	18	19	19	20	20

# KK01 FABRIC

## FEATURES

- Static dissipative woven fabric (carbon loaded yarns in 5 mm grid)
- Composition:** 74% Polyester, 24% Cotton, 2% Conductive fiber
- Fabric Weight:** 125 g/m<sup>2</sup>
- Finish:** Crease resists, workwear
- Resistance from point to point (Rp):** 10<sup>6</sup> - 10<sup>7</sup> Ohm
- Charging time:** < 2 seconds
- Electrical properties maintained after more than 50 industrial washings according to IEC/TS 61340-4-9:2016 and ANSI/ESD STM2.1:2018
- Complies with IEC/TS 61340-4-9:2016 and ANSI/ESD STM2.1:2018
- Developed for industrial washing

Machine washable up to 40 °C  
 Ironing at maximum 110 °C  
 Do not use acid or alkali!  
 Do not bleach!  
 Tumble dry at low temperature



Detailed washing instructions and warranty conditions on page 23!

## AVAILABLE COLOURS

Black (BK), Dark Green (DZ), Dark Gray (DG), Light Gray (LG), White (W), Navy Blue (NB), Royal Blue (RB), Light Blue (LB), Mint Green (MG), Light Green (LE), Burgundy (B), Red (R), Orange (O), Yellow (Y), Light Pink (LPK)



# TH55 FABRIC

## FEATURES

- Static dissipative woven fabric (carbon loaded yarns in 5 mm grid)
- Composition:** 63% Polyester 33% Cotton 4% Conductive fiber
- Fabric Weight:** 155 g/m<sup>2</sup>
- Finish:** Crease resists, workwear
- Resistance from point to point (Rp):** 10<sup>6</sup> - 10<sup>7</sup> Ohm
- Charging time:** < 2 seconds
- Electrical properties maintained after more than 50 industrial washings according to IEC/TS 61340-4-9:2016 and ANSI/ESD STM2.1:2018
- Complies with IEC/TS 61340-4-9:2016 and ANSI/ESD STM2.1:2018
- Developed for industrial washing

Machine washable up to 40 °C  
 Ironing at maximum 110 °C  
 Do not use acid or alkali!  
 Do not bleach!  
 Tumble dry at low temperature



Detailed washing instructions and warranty conditions on page 23!

## AVAILABLE COLOURS

Royal Blue (RB), Light Blue (LB), White (W)



# CT35 FABRIC

## FEATURES

- > Static dissipative woven fabric (carbon loaded yarns in 5 mm grid)
- > **Composition:** 69% Polyester 27% Cotton 4% Conductive fiber
- > **Fabric Weight:** 130 g/m<sup>2</sup>
- > **Finish:** Crease resists, workwear
- > **Resistance from point to point (Rp):** 10<sup>6</sup> - 10<sup>7</sup> Ohm
- > **Charging time:** < 2 seconds
- > Electrical properties maintained after more then 100 industrial washings according to IEC/TS 61340-4-9:2016 and ANSI/ESD STM2.1:2018
- > Complies with IEC/TS 61340-4-9:2016 and ANSI/ESD STM2.1:2018
- > Developed for industrial washing

 Machine washable up to 40 °C  
Ironing at maximum 110 °C  
Do not use acid or alkali!  
Do not bleach!  
Tumble dry at low temperature



Detailed washing instructions and warranty conditions on page 23!

## AVAILABLE COLOURS

White (W)

W

# TH65 FABRIC

## FEATURES

- > Static dissipative woven fabric (carbon loaded yarns in 5 mm grid)
- > **Composition:** 36% Polyester 60% Cotton 4% Conductive fiber
- > **Fabric Weight:** 160 g/m<sup>2</sup>
- > **Finish:** Crease resists, workwear
- > **Resistance from point to point (Rp):** 10<sup>6</sup> - 10<sup>7</sup> Ohm
- > **Charging time:** < 2 seconds
- > Electrical properties maintained after more then 50 industrial washings according to IEC/TS 61340-4-9:2016 and ANSI/ESD STM2.1:2018
- > Complies with IEC/TS 61340-4-9:2016 and ANSI/ESD STM2.1:2018
- > Developed for industrial washing

 Machine washable up to 40 °C  
Ironing at maximum 110 °C  
Do not use acid or alkali!  
Do not bleach!  
Tumble dry at low temperature



Detailed washing instructions and warranty conditions on page 23!

## AVAILABLE COLOURS

White (W)

W

# CR10 FABRIC

## FEATURES

- > Static dissipative woven fabric (carbon loaded yarns in 5 mm grid)
- > For Clean Room class 10-100 (ISO 4-5)
- > **Composition:** 98% Polyester 2% Conductive fiber
- > **Fabric Weight:** 110 g/m<sup>2</sup>
- > **Finish:** Crease resists, workwear
- > **Resistance from point to point (Rp):** 10<sup>6</sup> - 10<sup>7</sup> Ohm
- > **Charging time:** < 2 seconds
- > Electrical properties maintained after more than 50 industrial washings according to IEC/TS 61340-4-9:2016 and ANSI/ESD STM2.1:2018
- > Complies with IEC/TS 61340-4-9:2016 and ANSI/ESD STM2.1:2018
- > Developed for industrial washing

**!** Machine washable up to 40 °C  
 Ironing at maximum 110 °C  
 Do not use acid or alkali!  
 Do not bleach!  
 Tumble dry at low temperature



Detailed washing instructions and warranty conditions on page 23!

## AVAILABLE COLOURS

Light Blue (LB), White (W)



# CR10HI FABRIC

## FEATURES

- > Static dissipative woven fabric (carbon loaded yarns in 5 mm grid) For Clean Room (ISO 6-8)
- > **High Visibility fabric**
- > **Composition:** 98% Polyester 2% Conductive fiber
- > **Fabric Weight:** 125 g/m<sup>2</sup>
- > **Finish:** Crease resists, workwear
- > **Resistance from point to point (Rp):** 10<sup>6</sup> - 10<sup>7</sup> Ohm
- > **Charging time:** < 2 seconds
- > Electrical properties maintained after more than 50 industrial washings according to IEC/TS 61340-4-9:2016 and ANSI/ESD STM2.1:2018
- > Complies with IEC/TS 61340-4-9:2016 and ANSI/ESD STM2.1:2018
- > Developed for industrial washing

**!** Machine washable up to 40 °C  
 Ironing at maximum 110 °C  
 Do not use acid or alkali!  
 Do not bleach!  
 Tumble dry at low temperature



Detailed washing instructions and warranty conditions on page 23!

## AVAILABLE COLOURS

Orange (O), Yellow (Y)



# TS15 FABRIC

## FEATURES

- Static dissipative knitted fabric (with carbon yarn)
- **Composition:** 96% Cotton 4% Conductive fiber
- **Fabric Weight:** 150 g/m<sup>2</sup>
- **Finish:** Crease resist, workwear
- **Resistance from point to point (Rp):** 10<sup>6</sup> - 10<sup>7</sup> Ohm
- **Charging time:** < 2 seconds
- Electrical properties maintained after more then 40 industrial washings according to IEC/TS 61340-4-9:2016 and ANSI/ESD STM2.1:2018
- Complies with IEC/TS 61340-4-9:2016 and ANSI/ESD STM2.1:2018
- Developed for industrial washing

Machine washable up to 40 °C  
Ironing at maximum 110 °C  
Do not use acid or alkali!  
Do not bleach!  
Tumble dry at low temperature



Detailed washing instructions and warranty conditions on page 23!

## AVAILABLE COLOURS

Black (**BK**), Navy Blue (**NB**), Royal Blue (**RB**), Dark Gray (**DG**), Gray (**GA**), Burgundy (**B**), Orange (**O**), Dark Green (**GR**), White (**W**)



# TS16 FABRIC

## FEATURES

- Static dissipative knitted **PIQUE** fabric (with carbon yarn)
- **Composition:** 96% Cotton 4% Conductive fiber
- **Fabric Weight:** 210 g/m<sup>2</sup>
- **Finish:** Crease resists, workwear
- **Resistance from point to point (Rp):** 10<sup>6</sup> - 10<sup>7</sup> Ohm
- **Charging time:** < 2 seconds
- Electrical properties maintained after more then 40 industrial washings according to IEC/TS 61340-4-9:2016 and ANSI/ESD STM2.1:2018
- Complies with IEC/TS 61340-4-9:2016 and ANSI/ESD STM2.1:2018
- Developed for industrial washing

Machine washable up to 40 °C  
Ironing at maximum 110 °C  
Do not use acid or alkali!  
Do not bleach!  
Tumble dry at low temperature



Detailed washing instructions and warranty conditions on page 23!

## AVAILABLE COLOURS

Black (**BK**), Navy Blue (**NB**), White (**W**)



# PS21 FABRIC

## FEATURES

- > Static dissipative knitted fabric (with carbon yarn)
- > **Composition:** 47% Polyester 50% Cotton 3% Conductive fiber
- > **Fabric Weight:** 210 g/m<sup>2</sup>
- > **Finish:** Crease resists, workwear
- > **Resistance from point to point (Rp):** 10<sup>6</sup> - 10<sup>7</sup> Ohm
- > **Charging time:** < 2 seconds
- > Electrical properties maintained after more than 40 industrial washings according to IEC/TS 61340-4-9:2016 and ANSI/ESD STM2.1:2018
- > Complies with IEC/TS 61340-4-9:2016 and ANSI/ESD STM2.1:2018
- > Developed for industrial washing

! Machine washable up to 40 °C  
 Ironing at maximum 110 °C  
 Do not use acid or alkali!  
 Do not bleach!  
 Tumble dry at low temperature



Detailed washing instructions and warranty conditions on page 23!

## AVAILABLE COLOURS

Black (**BK**), Navy blue (**NB**), Royal Blue (**RB**), Purple (**PR**), Dark Gray (**DG**), Gray (**GA**), White (**W**),



# LY20 FABRIC

## FEATURES

- > Static dissipative knitted fabric (with carbon yarn)
- > **Composition:** 88% Cotton 8% Lycra 4% Conductive fiber
- > **Fabric Weight:** 200 g/m<sup>2</sup>
- > **Finish:** Crease resists, workwear
- > **Resistance from point to point (Rp):** 10<sup>6</sup> - 10<sup>7</sup> Ohm
- > **Charging time:** < 2 seconds
- > Electrical properties maintained after more than 40 industrial washings according to IEC/TS 61340-4-9:2016 and ANSI/ESD STM2.1:2018
- > Complies with IEC/TS 61340-4-9:2016 and ANSI/ESD STM2.1:2018
- > Developed for industrial washing

! Machine washable up to 40 °C  
 Ironing at maximum 110 °C  
 Do not use acid or alkali!  
 Do not bleach!  
 Tumble dry at low temperature



Detailed washing instructions and warranty conditions on page 23!

## AVAILABLE COLOURS

Black (**BK**)





# FL1 FABRIC

## FEATURES

- > Static dissipative Knitted fabric (with carbon yarn)
- > **Composition:** 96% Polyester 4% Conductive fiber
- > **Fabric Weight:** 280 g/m<sup>2</sup>
- > **Finish:** Fleece
- > **Resistance from point to point (Rp):** 10<sup>9</sup> - 10<sup>11</sup> Ohm
- > **Charging time:** < 2 seconds
- > Electrical properties maintained after more than 40 industrial washings according to IEC/TS 61340-4-9:2016 and ANSI/ESD STM2.1-2018
- > Complies with IEC/TS 61340-4-9:2016 and ANSI/ESD STM2.1:2018
- > Developed for industrial washing

**!** Machine washable up to 40 °C  
Ironing at maximum 110 °C  
Do not use acid or alkali!  
Do not bleach!  
Tumble dry at low temperature



Detailed washing instructions and warranty conditions on page 23!

## AVAILABLE COLOURS

Black (**BK**), Navy blue (**NB**), Dark gray (**DG**), Orange (**O**), Yellow (**Y**)



# WC10 FABRIC

## FEATURES

- > Static dissipative woven fabric (carbon loaded yarns in 5 mm grid)
- > Water repellent material, for outdoor use
- > For Clean Room also, class 1000
- > **Composition:** 98% Polyester 2% Conductive fiber
- > **Fabric Weight:** 120 g/m<sup>2</sup>
- > **Finish:** Crease resists, workwear
- > **Resistance from point to point (Rp):** 10<sup>6</sup> - 10<sup>7</sup> Ohm
- > **Charging time:** < 2 seconds
- > Electrical properties maintained after more than 50 industrial washings according to IEC/TS 61340-4-9:2016 and ANSI/ESD STM2.1:2018
- > Complies with IEC/TS 61340-4-9:2016 and ANSI/ESD STM2.1:2018
- > Developed for industrial washing

**!** Machine washable up to 40 °C  
Ironing at maximum 110 °C  
Do not use acid or alkali!  
Do not bleach!  
Tumble dry at low temperature



Detailed washing instructions and warranty conditions on page 23!

## AVAILABLE COLOURS

Navy Blue (**NB**)





# THSS FABRIC

## FEATURES

- > Static dissipative knitted fabric (with carbon yarn)
- > **Composition:** 48% Polyester 48% Cotton 4% Conductive fiber
- > **Fabric Weight:** 280 g/m<sup>2</sup>
- > **Finish:** Crease resists, workwear
- > **Resistance from point to point (Rp):** 10<sup>6</sup> - 10<sup>7</sup> Ohm
- > **Charging time:** < 2 seconds
- > Electrical properties maintained after more then 40 industrial washings according to IEC/TS 61340-4-9:2016 and ANSI/ESD STM2.1:2018
- > Complies with IEC/TS 61340-4-9:2016 and ANSI/ESD STM2.1:2018
- > Developed for industrial washing

**!** Machine washable up to 40 °C  
 Ironing at maximum 110 °C  
 Do not use acid or alkali!  
 Do not bleach!  
 Tumble dry at low temperature



Detailed washing instructions and warranty conditions on page 23!

## AVAILABLE COLOURS

Black (**BK**), Navy blue (**NB**), Royal blue (**RB**), Gray (**GA**), White (**W**)



# THSB FABRIC

## FEATURES

- > Static dissipative knitted fabric (with carbon yard)
- > Fluffy inner side
- > **Composition:** 48% Polyester 48% Cotton 4% Conductive fiber
- > **Fabric Weight:** 320 g/m<sup>2</sup>
- > **Finish:** Crease resists, workwear
- > **Resistance from point to point (Rp):** 10<sup>6</sup> - 10<sup>7</sup> Ohm
- > **Charging time:** < 2 seconds
- > Electrical properties maintained after more then 40 industrial washings according to IEC/TS 61340-4-9:2016 and ANSI/ESD STM2.1:2018
- > Complies with IEC/TS 61340-4-9:2016 and ANSI/ESD STM2.1:2018
- > Developed for industrial washing

**!** Machine washable up to 40 °C  
 Ironing at maximum 110 °C  
 Do not use acid or alkali!  
 Do not bleach!  
 Tumble dry at low temperature



Detailed washing instructions and warranty conditions on page 23!







## AVAILABLE COLOURS

Black (**BK**), Royal blue (**RB**)





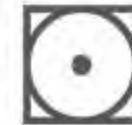

# WASHING INSTRUCTIONS

Conductive carbon fibers used in ESD fabrics are very sensitive to high temperatures, alkalis, acids, rinses (softeners) and bleaches. Inadequate use may cause damage to carbon fibers and ESD clothing may lose or significantly deteriorate ESD parameters. Therefore, wash ESD clothing very carefully, in each case please follow the instructions:

-  In order to preserve the long life of ESD clothings, please use industrial laundries who can provide controlled, documented washing procedures and environment!
-  Washing in cold or not warmer than 40 °C (104 °F) lukewarm water with neutral liquid detergent!
-  Do not use detergent containing bleach and fabric softener ingredient containing chlorine!
-  Bleachers are forbidden! Use of alkalis, acids or fabric softeners is prohibited!
-  Do not dry clean!
-  Drying in the open air and / or at a temperature up to 50 °C (120 °F) or less!
-  The ESD clothing does not require ironing but if absolutely necessary in that case the maximum temperature is 110 °C (230 °F) or lower!



# WARRANTY

- 
-  The warranty is strictly valid under controlled and documented industrial laundry conditions, concern the fabric washing cycle as specified in the technical data's.
  -  The warranty is NOT valid if the washing process is made in a home environment!
  -  The warranty covers ESD parameters and possible sewing errors according to IEC/TS 61340-4-9:2016 and ANSI/ESD STM2.1:2018 standard issued only!
  -  The warranty is not cover the size and shrinkage differences within the tolerances given on the size cart!

# ESS ESD SMOCK

1/2 LENGTH

## FEATURES

- » Available sizes: unisex XS - 5XL
- » 2 side pockets, 1 breast pocket with ESD symbol
- » Hidden snap-fasteners
- » Cuff with snap-fasteners

## AVAILABLE FABRICS AND COLOURS

KK01 FABRIC					TH55 FABRIC			CT35 FABRIC		TH65 FABRIC	
BK	DZ	DG	LG	W	RB	LB	W	W			W
NB	RB	LB	MG	LE	CR10 FABRIC			CR10HI FABRIC			
B	R	O	Y	LPK	LB	W	O	Y			



Embroidered or printed company logo or text available upon request!  
Individual custom made ESD Clothing also available!

## ORDERING CODE

**ESS - KK01 - LB L + DLB - RAN - W**  
 style fabric colour size option colour

DETAILS ON PAGE 112.





SIZE CHART (CM)	XS	S	M	L	XL	XXL	3XL	4XL	5XL
Cuff	32	33	34	35	36	36	37	37	38
Sleeve	57	59	63	67	71	71	73	73	74
Length	78	80	82	84	88	90	92	94	96
Chest	90	98	106	114	122	130	136	142	148
Hip	90	98	106	114	122	130	136	142	148
Shoulder	36	39	42	45	48	51	54	57	60

Size tolerance (Before washing): 2%

Certified clothing according to the 2018 ESD standard. It's proved with the following tag.



## OPTIONAL

STANDING COLLAR  CODE: AGL	CONDUCTIVE ELASTICATED CUFF  CODE: RAN	WAIST KNITTER  CODE: OTO
GROUNDING SMOCK - CODE: GND 		



DEMO VIDEO



# EFS ESD SMOCK

1/2 LENGTH

## FEATURES

- » Available sizes: female XS - 5XL
- » 2 side pockets, 1 breast pocket with ESD symbol
- » Hidden snap-fasteners
- » Cuff with snap-fasteners

## AVAILABLE FABRICS AND COLOURS

<b>KK01 FABRIC</b> BK DZ DG LG W NB RB LB MG LE B R O Y LPK					<b>TH55 FABRIC</b> RB LB W			<b>CT35 FABRIC</b> W		<b>TH65 FABRIC</b> W	
<b>CR10 FABRIC</b> LB W						<b>CR10HI FABRIC</b> O Y					

Embroidered or printed company logo or text available upon request!  
Individual custom made ESD Clothing also available!



## ORDERING CODE

**EFS** - **KK01** - **W** **L** + DLB - **RAN** - **W**  
 style fabric colour size option colour

DETAILS ON PAGE 112.

SIZE CHART (CM)	XS	S	M	L	XL	XXL	3XL	4XL	5XL
Cuff	32	33	34	35	36	36	37	37	38
Sleeve	57	59	63	67	71	71	73	73	74
Length	78	80	82	84	88	90	92	94	96
Chest	90	98	106	114	122	130	136	142	148
Hip	90	98	106	114	122	130	136	142	148
Shoulder	36	39	42	45	48	51	54	57	60

Size tolerance (Before washing): 2%



Certified clothing according to the 2018 ESD standard. It's proved with the following tag.

**NEW DESIGN**

DEMO VIDEO



# ESL ESD SMOCK

2/3 LENGTH

## FEATURES

- » Available sizes: unisex XS - 5XL
- » 2 side pockets, 1 breast pocket with ESD symbol
- » Hidden snap-fasteners
- » Cuff with snap-fasteners

## AVAILABLE FABRICS AND COLOURS

### KK01 FABRIC



### TH55 FABRIC



### CT35 FABRIC



### TH65 FABRIC



### CR10 FABRIC



### CR10HI FABRIC



Embroidered or printed company logo or text available upon request!  
Individual custom made ESD Clothing also available!

## ORDERING CODE

**ESL - KK01 - W L**  
style fabric colour size

DETAILS ON PAGE 112.

SIZE CHART (CM)	XS	S	M	L	XL	XXL	3XL	4XL	5XL
Cuff	32	33	34	35	36	36	37	37	38
Sleeve	57	59	63	67	71	71	73	73	74
Length	89	91	93	95	99	101	103	105	107
Chest	90	98	106	114	122	130	136	142	148
Hip	90	98	106	114	122	130	136	142	148
Shoulder	36	39	42	45	48	51	54	57	60

Size tolerance (Before washing): 2%

Certified clothing according to the 2018 ESD standard. It's proved with the following tag.



**NEW DESIGN**

DEMO VIDEO



OPTIONAL

STANDING COLLAR



CODE: AGL

CONDUCTIVE ELASTICATED CUFF



CODE: RAN

WAIST KNITTER



CODE: OTO

GROUNDING SMOCK - CODE: GND



# EFL ESD SMOCK

2/3 LENGTH

## FEATURES

- » Available sizes: female XS - 5XL
- » 2 side pockets, 1 breast pocket with ESD symbol
- » Hidden snap-fasteners
- » Cuff with snap-fasteners

## AVAILABLE FABRICS AND COLOURS

<b>KK01 FABRIC</b> BK DZ DG LG W NB RB LB MG LE B R O Y LPK					<b>TH55 FABRIC</b> RB LB W CR10 FABRIC LB W			<b>CT35 FABRIC</b> W CR10HI FABRIC O Y		<b>TH65 FABRIC</b> W	
----------------------------------------------------------------------	--	--	--	--	------------------------------------------------------	--	--	-------------------------------------------------	--	-------------------------	--

Embroidered or printed company logo or text available upon request!  
Individual custom made ESD Clothing also available!



## ORDERING CODE

**EFL - TH55 - LB L**  
 style fabric colour size

DETAILS ON PAGE 112.

SIZE CHART (CM)	XS	S	M	L	XL	XXL	3XL	4XL	5XL
Cuff	32	33	34	35	36	36	37	37	38
Sleeve	57	59	63	67	71	71	73	73	74
Length	89	91	93	95	99	101	103	105	107
Chest	90	98	106	114	122	130	136	142	148
Hip	90	98	106	114	122	130	136	142	148
Shoulder	36	39	42	45	48	51	54	57	60

Size tolerance (Before washing): 2%



Certified clothing according to the 2018 ESD standard. It's proved with the following tag.



DEMO VIDEO



# ESX ESD SMOCK

1/3 LENGTH

## FEATURES

- » Available sizes: unisex XS - 5XL
- » 2 side pockets, 1 breast pocket with ESD symbol
- » Hidden snap-fasteners
- » Cuff with snap-fasteners

## AVAILABLE FABRICS AND COLOURS

### KK01 FABRIC

BK DZ DG LG W

NB RB LB MG LE

B R O Y LPK

### TH55 FABRIC

RB LB W

### CR10 FABRIC

LB W

### CT35 FABRIC

W

### CR10HI FABRIC

O Y

### TH65 FABRIC

W

## OPTIONAL

STANDING COLLAR



CODE: AGL

CONDUCTIVE ELASTICATED CUFF

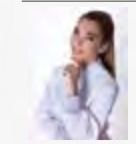

CODE: RAN

WAIST KNITTER

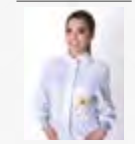

CODE: OTO

GROUNDING SMOCK - CODE: GND



**NEW DESIGN**

DEMO VIDEO



## ORDERING CODE

**ESX - TH55 - RB L**  
 style fabric colour size

DETAILS ON PAGE 112.

Certified clothing according to the 2018 ESD standard. It's proved with the following tag.



SIZE CHART (CM)	XS	S	M	L	XL	XXL	3XL	4XL	5XL
Cuff	32	33	34	35	36	36	37	37	38
Sleeve	57	59	63	67	71	71	73	73	74
Length	58	60	62	64	68	70	72	74	76
Chest	90	98	106	114	122	130	136	142	148
Hip	90	98	106	114	122	130	136	142	148
Shoulder	36	39	42	45	48	51	54	57	60

Size tolerance (Before washing): 2%



# EFX ESD SMOCK

1/3 LENGTH

## FEATURES

- » Available sizes: female XS - 5XL
- » 2 side pockets, 1 breast pocket with ESD symbol
- » Hidden snap-fasteners
- » Cuff with snap-fasteners

## AVAILABLE FABRICS AND COLOURS

<b>KK01 FABRIC</b> BK DZ DG LG W NB RB LB MG LE B R O Y LPK					<b>TH55 FABRIC</b> RB LB W			<b>CT35 FABRIC</b> W		<b>TH65 FABRIC</b> W	
<b>CR10 FABRIC</b> LB W						<b>CR10HI FABRIC</b> O Y					

Embroidered or printed company logo or text available upon request!  
Individual custom made ESD Clothing also available!



## ORDERING CODE

**EFX** - **KK01** - **LE L** + **DLB** - **RAN** - **W**  
 style fabric colour size option colour

DETAILS ON PAGE 112.

SIZE CHART (CM)	XS	S	M	L	XL	XXL	3XL	4XL	5XL
Cuff	32	33	34	35	36	36	37	37	38
Sleeve	57	59	63	67	71	71	73	73	74
Length	58	60	62	64	68	70	72	74	76
Chest	90	98	106	114	122	130	136	142	148
Hip	90	98	106	114	122	130	136	142	148
Shoulder	36	39	42	45	48	51	54	57	60

Size tolerance (Before washing): 2%



Certified clothing according to the 2018 ESD standard. It's proved with the following tag.



DEMO VIDEO



# ET ESD MALE TROUSERS



## FEATURES

- » Available sizes: Male XS - 5XL
- » Straight cut
- » 2 side pockets, 2 additional pockets on the legs, 1 hip pocket with ESD symbol
- » Rubberized waist with snap-fastener

## AVAILABLE FABRICS AND COLOURS

KK01 FABRIC					TH55 FABRIC			CT35 FABRIC		TH65 FABRIC
BK	DZ	DG	LG	W	RB	LB	W	W	W	
NB	RB	LB	MG	LE	CR10 FABRIC			CR10HI FABRIC		
B	R	O	Y	LPK	LB	W	O	Y		



Embroidered or printed company logo or text available upon request!  
Individual custom made ESD Clothing also available!



DEMO VIDEO



## ORDERING CODE

**ET** - **KK01** - **DG** **L**  
style fabric colour size

Certified clothing according to the 2018 ESD standard. It's proved with the following tag.



**DETAILS ON PAGE 112.**

SIZE CHART (CM)	XS	S	M	L	XL	XXL	3XL	4XL	5XL
Length external	102	104	106	108	110	112	114	116	118
Hip	98	102	107	111	115	119	123	128	132

Size tolerance (Before washing): 2%

# ETF ESD FEMALE TROUSERS

## FEATURES

- » Available sizes: female XS - 5XL
- » Straight cut
- » 2 side pockets, 2 additional pockets on the legs, 1 hip pocket with ESD symbol
- » Rubberized waist with snap-fastener

## AVAILABLE FABRICS AND COLOURS

KK01 FABRIC					TH55 FABRIC			CT35 FABRIC		TH65 FABRIC	
BK	DZ	DG	LG	W	RB	LB	W	W	W		
NB	RB	LB	MG	LE	CR10 FABRIC		CR10HI FABRIC				
B	R	O	Y	LPK	LB	W	O	Y			

Embroidered or printed company logo or text available upon request!  
Individual custom made ESD Clothing also available!



## ORDERING CODE

**ETF - KK01 - DG L**  
style fabric colour size



DEMO VIDEO



DETAILS ON PAGE 112.

SIZE CHART (CM)	XS	S	M	L	XL	XXL	3XL	4XL	5XL
Length external	102	104	106	108	110	112	114	116	118
Hip	84	90	96	102	108	114	120	126	132

Size tolerance (Before washing): 2%



Certified clothing according to the 2018 ESD standard. It's proved with the following tag.

# OT ESD TROUSERS WITH BRIDLES



## FEATURES

- » Available sizes: unisex XS - 5XL
- » 2 side pockets, 1 breast pocket with ESD symbol
- » 2 side pockets on the legs
- » 2 quick release buckles

## AVAILABLE FABRICS AND COLOURS

KK01 FABRIC					TH55 FABRIC			CT35 FABRIC		TH65 FABRIC
BK	DZ	DG	LG	W	RB	LB	W	W	W	
NB	RB	LB	MG	LE	CR10 FABRIC			CR10HI FABRIC		
B	R	O	Y	LPK	LB	W	O	Y		



Embroidered or printed company logo or text available upon request!  
Individual custom made ESD Clothing also available!



DEMO VIDEO



## ORDERING CODE

**OT** - **KK01** - **RB** **L**  
style fabric colour size

Certified clothing according to the 2018 ESD standard. It's proved with the following tag.



**DETAILS ON PAGE 112.**

SIZE CHART (CM)	XS	S	M	L	XL	XXL	3XL	4XL	5XL
Length external	102	104	106	108	110	112	114	116	118
Hip	98	102	107	111	115	119	123	128	132

Size tolerance (Before washing): 2%

# OJ ESD JACKET

## FEATURES

- » Available sizes: unisex XS - 5XL
- » 2 side pockets, 2 breast pockets
- » ESD logo on breast pocket
- » Hidden zipper
- » Rubberized cuff

## AVAILABLE FABRICS AND COLOURS

KK01 FABRIC					TH55 FABRIC			CT35 FABRIC		TH65 FABRIC	
BK	DZ	DG	LG	W	RB	LB	W	W		W	
NB	RB	LB	MG	LE	CR10 FABRIC		CR10HI FABRIC				
B	R	O	Y	LPK	LB	W	O	Y			

Embroidered or printed company logo or text available upon request!  
Individual custom made ESD Clothing also available!



## ORDERING CODE

**OJ - KK01 - RB L**  
style fabric colour size

## DEMO VIDEO



DETAILS ON PAGE 112.

SIZE CHART (CM)	XS	S	M	L	XL	XXL	3XL	4XL	5XL
Sleeve	61	63	67	71	75	76	77	77	78
Length	63	65	67	69	71	73	75	76	77
Chest	90	98	106	114	122	130	136	142	148
Shoulder	40	43	46	49	52	55	58	61	65
Shoulder outline	56	58	60	62	64	66	68	70	72

Size tolerance (Before washing): 2%



Certified clothing according to the 2018 ESD standard. It's proved with the following tag.

# HIV ESD HIGH VISIBILITY VEST



## FEATURES

- » Available sizes: Unisex S-5XL
- » With reflective stripes
- » ESD symbol on chest
- » Hidden snap-fasteners

## AVAILABLE FABRICS AND COLOURS

### CR10HI FABRIC



Embroidered or printed company logo or text available upon request!  
Individual custom made ESD Clothing also available!

## DEMO VIDEO



## ORDERING CODE

**HIV** - **CR10HI** - **O** **L**  
style fabric colour size

Certified clothing according to the 2018 ESD standard. It's proved with the following tag.



**DETAILS ON PAGE 112.**

SIZE CHART (CM)	XS	S	M	L	XL	XXL	3XL	4XL	5XL
Chest	114	118	122	126	130	134	138	142	118
Length	61	63	65	67	69	71	73	75	132

Size tolerance (Before washing): 2%

# KOT ESD TABARD



## FEATURES

- » Available sizes: XS - 5XL
- » ESD symbol on pocket
- » 1 pocket
- » Adjustable side straps with snap fasteners

## AVAILABLE FABRICS AND COLOURS

KK01 FABRIC					TH55 FABRIC			CT35 FABRIC		TH65 FABRIC
BK	DZ	DG	LG	W	RB	LB	W	W	W	
NB	RB	LB	MG	LE	CR10 FABRIC			CR10HI FABRIC		
B	R	O	Y	LPK	LB	W	O	Y		



Embroidered or printed company logo or text available upon request!  
Individual custom made ESD Clothing also available!

## DEMO VIDEO



## ORDERING CODE

**KOT** - **KK01** - **BK** **L**  
style fabric colour size

Certified clothing according to the 2018 ESD standard. It's proved with the following tag.



DETAILS ON PAGE 112.										
SIZE CHART (CM)	XS	S	M	L	XL	XXL	3XL	4XL	5XL	
Length	76	78	80	82	84	86	88	90	92	

Size tolerance (Before washing): 2%

# APR ESD APRON

## FEATURES

- » Available sizes: Unisex, one size
- » ESD symbol on chest

## AVAILABLE FABRICS AND COLOURS

KK01 FABRIC					TH55 FABRIC			CT35 FABRIC		TH65 FABRIC	
BK	DZ	DG	LG	W	RB	LB	W	W		W	
NB	RB	LB	MG	LE	CR10 FABRIC			CR10HI FABRIC			
B	R	O	Y	LPK	LB	W		O	Y		

Embroidered or printed company logo or text available upon request!  
Individual custom made ESD Clothing also available!



## ORDERING CODE

**APR - KK01 - BK**  
style fabric colour

## DEMO VIDEO



Certified clothing according to the 2018 ESD standard. It's proved with the following tag.



# BB ESD BASEBALL TYPE CAP



## FEATURES

- » Available sizes: Unisex, one size
- » Sun visor
- » With ESD Symbol
- » Rubberized back

## AVAILABLE FABRICS AND COLOURS

KK01 FABRIC					TH55 FABRIC			CT35 FABRIC		TH65 FABRIC
BK	DZ	DG	LG	W	RB	LB	W	W	W	
NB	RB	LB	MG	LE	CR10 FABRIC			CR10HI FABRIC		
B	R	O	Y	LPK	LB	W	O	Y		



Embroidered or printed company logo or text available upon request!  
Individual custom made ESD Clothing also available!

## ORDERING CODE

**BB** - **KK01** - **DG**  
style fabric colour

## DEMO VIDEO



Certified clothing according to the 2018 ESD standard. It's proved with the following tag.



# BP ESD CAP WITH NET

## FEATURES

- » Available sizes: Unisex, one size
- » Breathable net on the top of the cap
- » With ESD Symbol
- » Plastic size adjuster on the back

## AVAILABLE FABRICS AND COLOURS

KK01 FABRIC					TH55 FABRIC			CT35 FABRIC		TH65 FABRIC	
BK	DZ	DG	LG	W	RB	LB	W	W		W	
NB	RB	LB	MG	LE	CR10 FABRIC		CR10HI FABRIC				
B	R	O	Y	LPK	LB	W	O	Y			

Embroidered or printed company logo or text available upon request!  
Individual custom made ESD Clothing also available!



## DEMO VIDEO



## ORDERING CODE

**BP** - **KK01** - **LPK**  
style fabric colour



Certified clothing according to the 2018 ESD standard. It's proved with the following tag.

# PF1 ESD PREMIUM SMOCK



2/3 LENGTH

## FEATURES

- » Sizes: female XS - 5XL
- » 2 side pockets
- » Hidden snap-fasteners
- » Cuff with snap-fasteners

## OPTIONAL

GROUNDING SMOCK - CODE: GND



## AVAILABLE FABRICS AND COLOURS

### KK01 FABRIC



### TH55 FABRIC



CHOOSE THE MOST MATCHING COLOUR COMBINATION OF YOUR COMPANY!



Embroidered or printed company logo or text available upon request!  
Individual custom made ESD Clothing also available!

## DEMO VIDEO



## ORDERING CODE

**PF1 - KK01 - Y - DG L**  
style fabric colour1 colour2 size

DETAILS ON PAGE 113.

Certified clothing according to the 2018 ESD standard. It's proved with the following tag.



SIZE CHART (CM)	XS	S	M	L	XL	XXL	3XL	4XL	5XL
Cuff	32	33	34	35	36	36	37	37	38
Sleeve	57	59	63	67	71	71	73	73	74
Length	89	91	93	95	99	101	103	105	107
Chest	90	98	106	114	122	130	136	142	148
Hip	90	98	106	114	122	130	136	142	148
Shoulder	36	39	42	45	48	51	54	57	60

Size tolerance (Before washing): 2%

# PS1 ESD PREMIUM SMOCK

2/3 LENGTH

## OPTIONAL

GROUNDING SMOCK - CODE: GND



## FEATURES

- » Sizes: Male XS - 5XL
- » 2 side pockets, 1 hidden breast pocket
- » Hidden snap-fasteners
- » Cuff with snap-fasteners

## AVAILABLE FABRICS AND COLOURS

### TH55 FABRIC



### KK01 FABRIC



CHOOSE THE MOST MATCHING COLOUR COMBINATION OF YOUR COMPANY!



Embroidered or printed company logo or text available upon request!  
Individual custom made ESD Clothing also available!



## ORDERING CODE

**PS1** - **KK01** - **O** - **RB** **L**  
style fabric colour1 colour2 size

## DEMO VIDEO



DESIGNED BY MS. *Gáspár Zsófia*

DETAILS ON PAGE 113.

SIZE CHART (CM)	XS	S	M	L	XL	XXL	3XL	4XL	5XL
Cuff	32	33	34	35	36	36	37	37	38
Sleeve	57	59	63	67	71	71	73	73	74
Length	89	91	93	95	99	101	103	105	107
Chest	90	98	106	114	122	130	136	142	148
Hip	90	98	106	114	122	130	136	142	148
Shoulder	36	39	42	45	48	51	54	57	60

Size tolerance (Before washing): 2%



Certified clothing according to the 2018 ESD standard. It's proved with the following tag.

# PF2 ESD PREMIUM SMOCK



2/3 LENGTH

## FEATURES

- » Sizes: female XS - 5XL
- » 2 side pockets
- » Hidden snap-fasteners
- » Rubberized Cuff

## OPTIONAL

GROUNDING SMOCK - CODE: GND



## AVAILABLE FABRICS AND COLOURS

### KK01 FABRIC



### TH55 FABRIC



CHOOSE THE MOST MATCHING COLOUR COMBINATION OF YOUR COMPANY!



Embroidered or printed company logo or text available upon request!  
Individual custom made ESD Clothing also available!

## DEMO VIDEO



## ORDERING CODE

**PF2** - **KK01** - **LG** - **B** **L**  
style fabric colour1 colour2 size

DETAILS ON PAGE 113.

Certified clothing according to the 2018 ESD standard. It's proved with the following tag.



SIZE CHART (CM)	XS	S	M	L	XL	XXL	3XL	4XL	5XL
Cuff	32	33	34	35	36	36	37	37	38
Sleeve	57	59	63	67	71	71	73	73	74
Length	89	91	93	95	99	101	103	105	107
Chest	90	98	106	114	122	130	136	142	148
Hip	90	98	106	114	122	130	136	142	148
Shoulder	36	39	42	45	48	51	54	57	60

Size tolerance (Before washing): 2%

DESIGNED BY MS. Vandornyzik Andrea

# PS2 ESD PREMIUM SMOCK

2/3 LENGTH

## OPTIONAL

GROUNDING SMOCK - CODE: GND



## FEATURES

- » Sizes: Male XS - 5XL
- » 2 side pockets
- » Hidden snap-fasteners
- » Rubberized cuff

## AVAILABLE FABRICS AND COLOURS

### TH55 FABRIC



### KK01 FABRIC



CHOOSE THE MOST MATCHING COLOUR COMBINATION OF YOUR COMPANY!



Embroidered or printed company logo or text available upon request!  
Individual custom made ESD Clothing also available!



## ORDERING CODE

**PS2** - **KK01** - **W** - **DZ** **L**  
style fabric colour1 colour2 size

## DEMO VIDEO



DETAILS ON PAGE 113.

SIZE CHART (CM)	XS	S	M	L	XL	XXL	3XL	4XL	5XL
Cuff	32	33	34	35	36	36	37	37	38
Sleeve	57	59	63	67	71	71	73	73	74
Length	89	91	93	95	99	101	103	105	107
Chest	90	98	106	114	122	130	136	142	148
Hip	90	98	106	114	122	130	136	142	148
Shoulder	36	39	42	45	48	51	54	57	60

Size tolerance (Before washing): 2%



Certified clothing according to the 2018 ESD standard. It's proved with the following tag.

DESIGNED BY MS. Vandorniyik Andrea

# PF3 ESD PREMIUM SMOCK

2/3 LENGTH

## FEATURES

- » Sizes: female XS - 5XL
- » 2 side pocketsts
- » Hidden snap-fasteners
- » Cuff with snap-fasteners

## OPTIONAL

GROUNDING SMOCK - CODE: GND



## AVAILABLE FABRICS AND COLOURS

### KK01 FABRIC



### TH55 FABRIC



CHOOSE THE MOST MATCHING COLOUR COMBINATION OF YOUR COMPANY!



Embroidered or printed company logo or text available upon request!  
Individual custom made ESD Clothing also available!

## ORDERING CODE

**PF3** - **KK01** - **B** - **Y** **L**  
style fabric colour1 colour2 size

## DEMO VIDEO



DETAILS ON PAGE 113.

SIZE CHART (CM)	XS	S	M	L	XL	XXL	3XL	4XL	5XL
Cuff	32	33	34	35	36	36	37	37	38
Sleeve	57	59	63	67	71	71	73	73	74
Length	89	91	93	95	99	101	103	105	107
Chest	90	98	106	114	122	130	136	142	148
Hip	90	98	106	114	122	130	136	142	148
Shoulder	36	39	42	45	48	51	54	57	60

Size tolerance (Before washing): 2%

Certified clothing according to the 2018 ESD standard. It's proved with the following tag.



DESIGNED BY MS. *Kevdas Berbala*

# PS3 ESD PREMIUM SMOCK

2/3 LENGTH

## OPTIONAL

GROUNDING SMOCK - CODE: GND

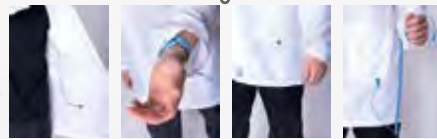

## FEATURES

- » Sizes: Male XS - 5XL
- » 2 side pockets
- » Hidden snap-fasteners
- » Cuff with snap-fasteners

## AVAILABLE FABRICS AND COLOURS

### TH55 FABRIC



### KK01 FABRIC



CHOOSE THE MOST MATCHING COLOUR COMBINATION OF YOUR COMPANY!



Embroidered or printed company logo or text available upon request!  
Individual custom made ESD Clothing also available!



## ORDERING CODE

**PS3** - **KK01** - **NB** - **MG** **L**  
style fabric colour1 colour2 size

## DEMO VIDEO



DETAILS ON PAGE 113.

SIZE CHART (CM)	XS	S	M	L	XL	XXL	3XL	4XL	5XL
Cuff	32	33	34	35	36	36	37	37	38
Sleeve	57	59	63	67	71	71	73	73	74
Length	89	91	93	95	99	101	103	105	107
Chest	90	98	106	114	122	130	136	142	148
Hip	90	98	106	114	122	130	136	142	148
Shoulder	36	39	42	45	48	51	54	57	60

Size tolerance (Before washing): 2%



Certified clothing according to the 2018 ESD standard. It's proved with the following tag.



DESIGNED BY MS. *Kovacs Borbala*



# ING ESD MALE BUSINESS SHIRT



## FEATURES

- » Available sizes: Male XS - 5XL
- » Business style
- » 1 breast pocket
- » ESD symbol on sleeve
- » With buttons

## AVAILABLE FABRICS AND COLOURS

KK01 FABRIC					TH55 FABRIC			TH65 FABRIC	
BK	DZ	DG	LG	W	RB	LB	W	W	
NB	RB	LB	MG	LE	CT35 FABRIC				
B	R	O	Y	LPK	W				



Embroidered or printed company logo or text available upon request!  
Individual custom made ESD Clothing also available!

## DEMO VIDEO



## ORDERING CODE

**ING - KK01 - W L**  
style fabric colour size

Certified clothing according to the 2018 ESD standard. It's proved with the following tag.



DETAILS ON PAGE 113.

SIZE CHART (CM)	XS	S	M	L	XL	XXL	3XL	4XL	5XL
Sleeve	56	58	60	62	64	66	68	70	70
Length	66	68	70	72	74	76	78	80	80
Chest	94	100	106	112	118	124	130	136	142
Shoulder	39	41	43	45	47	49	51	54	57
Cuff outline	23	24	25	26	27	28	29	30	31

Size tolerance (Before washing): 2%

# IFG ESD FEMALE BUSINESS SHIRT

## FEATURES

- » Available sizes: female XS - 5XL
- » ESD symbol on sleeve
- » With buttons

## AVAILABLE FABRICS AND COLOURS

KK01 FABRIC					TH55 FABRIC			TH65 FABRIC	
BK	DZ	DG	LG	W	RB	LB	W	W	
NB	RB	LB	MG	LE	CT35 FABRIC				
B	R	O	Y	LPK	W				

Embroidered or printed company logo or text available upon request!  
Individual custom made ESD Clothing also available!



## ORDERING CODE

**IFG** - **KK01** - **W** **L**  
style fabric colour size

## DEMO VIDEO



### DETAILS ON PAGE 113.

SIZE CHART (CM)	XS	S	M	L	XL	XXL	3XL	4XL	5XL
Sleeve	56	58	60	62	64	66	68	70	70
Length	56	58	60	62	64	66	68	70	70
Chest	84	88	92	96	100	104	108	112	116
Shoulder	40	40	42	44	46	48	50	52	54
Cuff outline	21	22	23	24	25	26	27	28	29

Size tolerance (Before washing): 2%



Certified clothing according to the 2018 ESD standard. It's proved with the following tag.

# NT ESD MALE SUITE PANTS



## FEATURES

- » Available sizes: Male XS - 5XL
- » Straight cut
- » 2 side pockets, 1 hip pocket with ESD symbol

## AVAILABLE FABRICS AND COLOURS

KK01 FABRIC					TH55 FABRIC			TH65 FABRIC	
BK	DZ	DG	LG	W	RB	LB	W	W	
NB	RB	LB	MG	LE	CT35 FABRIC				
B	R	O	Y	LPK	W				



Embroidered or printed company logo or text available upon request!  
Individual custom made ESD Clothing also available!

## DEMO VIDEO



## ORDERING CODE

**NT** - **KK01** - **BK** **L**  
style fabric colour size

Certified clothing according to the 2018 ESD standard. It's proved with the following tag.



DETAILS ON PAGE 112.

SIZE CHART (CM)	XS	S	M	L	XL	XXL	3XL	4XL	5XL
Waist	80	84	88	92	96	100	104	109	113
Hip	98	102	107	111	115	119	123	128	132
Length external	102	104	106	108	110	112	114	116	118

Size tolerance (Before washing): 2%

# NTF ESD FEMALE SUITE PANTS

## FEATURES

- » Available sizes: female XS - 5XL
- » Straight cut
- » 2 side pockets
- » With ESD Symbol

## AVAILABLE FABRICS AND COLOURS

KK01 FABRIC					TH55 FABRIC			TH65 FABRIC	
BK	DZ	DG	LG	W	RB	LB	W	W	
NB	RB	LB	MG	LE	CT35 FABRIC				
B	R	O	Y	LPK	W				

Embroidered or printed company logo or text available upon request!  
Individual custom made ESD Clothing also available!



## ORDERING CODE

**NTF - KK01 - BK L**  
style fabric colour size

## DEMO VIDEO



DETAILS ON PAGE 112.

SIZE CHART (CM)	XS	S	M	L	XL	XXL	3XL	4XL	5XL
Waist	68	72	76	80	84	88	92	97	101
Hip	98	102	107	111	115	119	123	128	132
Length external	102	104	106	108	110	112	114	116	118

Size tolerance (Before washing): 2%



Certified clothing according to the 2018 ESD standard. It's proved with the following tag.

# SKI ESD SKIRT



## FEATURES

- » Available sizes: XS – 5XL
- » Length: knee-high
- » Pencil style
- » with ESD Symbol

## AVAILABLE FABRICS AND COLOURS

KK01 FABRIC					TH55 FABRIC			TH65 FABRIC	
BK	DZ	DG	LG	W	RB	LB	W	W	
NB	RB	LB	MG	LE	CT35 FABRIC				
B	R	O	Y	LPK	W				



Embroidered or printed company logo or text available upon request!  
Individual custom made ESD Clothing also available!

## DEMO VIDEO



## ORDERING CODE

**SKI - KK01 - BK L**  
style fabric colour size

Certified clothing according to the 2018 ESD standard. It's proved with the following tag.



DETAILS ON PAGE 113.

SIZE CHART (CM)	XS	S	M	L	XL	XXL	3XL	4XL	5XL
Waist	76	80	84	88	92	96	100	104	108
Hip	98	102	106	110	114	118	122	126	130
Length	59	61	63	65	67	69	71	71	71

Size tolerance (Before washing): 2%

# TKO/F ESD T-SHIRT

SHORT SLEEVE, ROUND NECK, NO POCKET

## FEATURES

- » Available sizes: unisex XS - 5XL, female (F) XS - 5XL
- » **Female model:** Slim style
- » Round neck
- » Without any pocket
- » ESD symbol on sleeve

## AVAILABLE FABRICS AND COLOURS

### TS15 FABRIC



### PS21 FABRIC



### TS16 FABRIC



Embroidered or printed company logo or text available upon request!  
Individual custom made ESD Clothing also available!



**The given sizes are before washing.**  
After washing there can be 8-10 % shrinking of the width (especially the chest)!

## ORDERING CODE

**TKOF** - **TS15** - **BK** **L**  
style female fabric colour size

### DEMO VIDEOS



Certified clothing according to the 2018 ESD standard. It's proved with the following tag.



### DETAILS AND FEMALE SIZE CHART ON PAGE 112.

SIZE CHART (CM)	XS	S	M	L	XL	XXL	3XL	4XL	5XL
Sleeve	20,5	21,5	22,5	23,5	25	26,5	28	29,5	31
Length	63	66	69	72	75	78	81	84	87
Chest	100	106	112	118	124	130	136	142	148
Shoulder	41	43	45	47	49	51	54	57	60

Size tolerance (Before washing): 2%

# TKZ/F ESD T-SHIRT

SHORT SLEEVE, ROUND NECK, BREAST POCKET

## FEATURES

- » Available sizes: unisex XS - 5XL, female (F) XS - 5XL
- » **Female model:** Slim style
- » Round neck
- » Breast pocket with ESD symbol

## AVAILABLE FABRICS AND COLOURS

### TS15 FABRIC



### PS21 FABRIC



### TS16 FABRIC



Embroidered or printed company logo or text available upon request!  
Individual custom made ESD Clothing also available!



The given sizes are before washing.  
After washing there can be 8-10 % shrinking of the width (especially the chest)!



## ORDERING CODE

**TKZF - TS15 - GA L**  
style female fabric colour size

## DEMO VIDEOS



### DETAILS AND FEMALE SIZE CHART ON PAGE 112.

SIZE CHART (CM)	XS	S	M	L	XL	XXL	3XL	4XL	5XL
Sleeve	20,5	21,5	22,5	23,5	25	26,5	28	29,5	31
Length	63	66	69	72	75	78	81	84	87
Chest	100	106	112	118	124	130	136	142	148
Shoulder	41	43	45	47	49	51	54	57	60

Size tolerance (Before washing): 2%



Certified clothing according to the 2018 ESD standard. It's proved with the following tag.

# LKO/F ESD T-SHIRT

LONG SLEEVE, ROUND NECK, NO POCKET

## FEATURES

- » Available sizes: unisex XS - 5XL, female (F) XS - 5XL
- » **Female model:** Slim style
- » Round neck
- » Without any pocket
- » ESD symbol on sleeve

## AVAILABLE FABRICS AND COLOURS

### TS15 FABRIC



### PS21 FABRIC



### TS16 FABRIC



Embroidered or printed company logo or text available upon request!  
Individual custom made ESD Clothing also available!



**The given sizes are before washing.**  
After washing there can be 8-10 % shrinking of the width (especially the chest)!

## ORDERING CODE

**LKOF - TS15 - BK L**  
style female fabric colour size

### DEMO VIDEOS



Certified clothing according to the 2018 ESD standard. It's proved with the following tag.

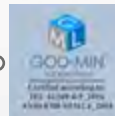

### DETAILS AND FEMALE SIZE CHART ON PAGE 112.

SIZE CHART (CM)	XS	S	M	L	XL	XXL	3XL	4XL	5XL
Sleeve	51,5	53	57	61	63	65	67	67	68
Length	63	66	69	72	75	78	81	84	87
Chest	100	106	112	118	124	130	136	142	148
Shoulder	41	43	45	47	49	51	54	57	60

Size tolerance (Before washing): 2%



# LKZ/F ESD T-SHIRT

LONG SLEEVE, ROUND NECK, BREAST POCKET

## FEATURES

- » Available sizes: unisex XS - 5XL, female (F) XS - 5XL
- » **Female model:** Slim style
- » Round neck
- » Breast pocket with ESD symbol

## AVAILABLE FABRICS AND COLOURS

### TS15 FABRIC



### PS21 FABRIC



### TS16 FABRIC



Embroidered or printed company logo or text available upon request!  
Individual custom made ESD Clothing also available!



The given sizes are before washing.  
After washing there can be 8-10 % shrinking of the width (especially the chest)!



## ORDERING CODE

**LKZF** - **TS15** - **GA** **L**  
style female fabric colour size

## DEMO VIDEOS



DETAILS AND FEMALE SIZE CHART ON PAGE 112.

SIZE CHART (CM)	XS	S	M	L	XL	XXL	3XL	4XL	5XL
Sleeve	51,5	53	57	61	63	65	67	67	68
Length	63	66	69	72	75	78	81	84	87
Chest	100	106	112	118	124	130	136	142	148
Shoulder	41	43	45	47	49	51	54	57	60

Size tolerance (Before washing): 2%



Certified clothing according to the 2018 ESD standard. It's proved with the following tag.

# TGO/F ESD T-SHIRT

SHORT SLEEVE, V-NECK, NO POCKET

## FEATURES

- » Available sizes: unisex XS - 5XL, female (F) XS - 5XL
- » **Female model:** Slim style
- » V-neck
- » Without any pocket
- » ESD symbol on sleeve

## AVAILABLE FABRICS AND COLOURS

### TS15 FABRIC



### PS21 FABRIC



### TS16 FABRIC



Embroidered or printed company logo or text available upon request!  
Individual custom made ESD Clothing also available!



**The given sizes are before washing.**  
After washing there can be 8-10 % shrinking of the width (especially the chest)!

## ORDERING CODE

**TGO****F** - **TS15** - **GR** **L**  
style female fabric colour size

### DEMO VIDEOS



Certified clothing according to the 2018 ESD standard. It's proved with the following tag.



### DETAILS AND FEMALE SIZE CHART ON PAGE 112.

SIZE CHART (CM)	XS	S	M	L	XL	XXL	3XL	4XL	5XL
Sleeve	20,5	21,5	22,5	23,5	25	26,5	28	29,5	31
Length	63	66	69	72	75	78	81	84	87
Chest	100	106	112	118	124	130	136	142	148
Shoulder	41	43	45	47	49	51	54	57	60

Size tolerance (Before washing): 2%

# TGZ/F ESD T-SHIRT

SHORT SLEEVE, V-NECK, BREAST POCKET

## FEATURES

- » Available sizes: unisex XS - 5XL, female (F) XS - 5XL
- » Female model: Slim style
- » V-neck
- » Breast pocket with ESD symbol

## AVAILABLE FABRICS AND COLOURS

### TS15 FABRIC



### PS21 FABRIC



### TS16 FABRIC



Embroidered or printed company logo or text available upon request!  
Individual custom made ESD Clothing also available!



The given sizes are before washing.  
After washing there can be 8-10 % shrinking of the width (especially the chest)!



## ORDERING CODE

**TGZF - TS15 - DG L**  
style female fabric colour size

## DEMO VIDEOS



### DETAILS AND FEMALE SIZE CHART ON PAGE 112.

SIZE CHART (CM)	XS	S	M	L	XL	XXL	3XL	4XL	5XL
Sleeve	20,5	21,5	22,5	23,5	25	26,5	28	29,5	31
Length	63	66	69	72	75	78	81	84	87
Chest	100	106	112	118	124	130	136	142	148
Shoulder	41	43	45	47	49	51	54	57	60

Size tolerance (Before washing): 2%



Certified clothing according to the 2018 ESD standard. It's proved with the following tag.

# LGO/F ESD T-SHIRT

LONG SLEEVE, V-NECK, NO POCKET

## FEATURES

- » Available sizes: unisex XS - 5XL, female (F) XS - 5XL
- » **Female model:** Slim style
- » V-neck
- » Without any pocket
- » ESD symbol on sleeve

## AVAILABLE FABRICS AND COLOURS

### TS15 FABRIC



### PS21 FABRIC



### TS16 FABRIC



Embroidered or printed company logo or text available upon request!  
Individual custom made ESD Clothing also available!



**The given sizes are before washing.**  
After washing there can be 8-10 % shrinking of the width (especially the chest)!

## ORDERING CODE

**LGO****F** - **TS15** - **GR** **L**  
style female fabric colour size

### DEMO VIDEOS



Certified clothing according to the 2018 ESD standard. It's proved with the following tag.



### DETAILS AND FEMALE SIZE CHART ON PAGE 112.

SIZE CHART (CM)	XS	S	M	L	XL	XXL	3XL	4XL	5XL
Sleeve	51,5	53	57	61	63	65	67	67	68
Length	63	66	69	72	75	78	81	84	87
Chest	100	106	112	118	124	130	136	142	148
Shoulder	41	43	45	47	49	51	54	57	60

Size tolerance (Before washing): 2%

# LGZ/F ESD T-SHIRT

LONG SLEEVE, V-NECK, BREAST POCKET

## FEATURES

- » Available sizes: unisex XS - 5XL, female (F) XS - 5XL
- » Female model: Slim style
- » V-neck
- » Breast pocket with ESD symbol

## AVAILABLE FABRICS AND COLOURS

### TS15 FABRIC



### PS21 FABRIC



### TS16 FABRIC



Embroidered or printed company logo or text available upon request!  
Individual custom made ESD Clothing also available!



The given sizes are before washing.  
After washing there can be 8-10 % shrinking of the width (especially the chest)!



## ORDERING CODE

**LGZF - TS15 - DG L**  
style female fabric colour size

## DEMO VIDEOS



### DETAILS AND FEMALE SIZE CHART ON PAGE 112.

SIZE CHART (CM)	XS	S	M	L	XL	XXL	3XL	4XL	5XL
Sleeve	51,5	53	57	61	63	65	67	67	68
Length	63	66	69	72	75	78	81	84	87
Chest	100	106	112	118	124	130	136	142	148
Shoulder	41	43	45	47	49	51	54	57	60

Size tolerance (Before washing): 2%



Certified clothing according to the 2018 ESD standard. It's proved with the following tag.

# PGO/F ESD POLO-SHIRT

SHORT SLEEVE, COLLAR, NO POCKET

## FEATURES

- » Available sizes: unisex XS - 5XL, female (F) XS - 5XL
- » **Female model:** Slim style
- » Without any pocket
- » ESD symbol on sleeve
- » Hidden snap-fasteners

## OPTIONAL

- + Collar from its own fabric  
**CODE: SAA**

## AVAILABLE FABRICS AND COLOURS

### TS15 FABRIC



### PS21 FABRIC



### TS16 FABRIC



Embroidered or printed company logo or text available upon request!  
Individual custom made ESD Clothing also available!



**The given sizes are before washing.**  
After washing there can be 8-10 % shrinking of the width (especially the chest)!

## ORDERING CODE

**PGO**F - **PS21** - **NB** **L**  
style female fabric colour size

## DEMO VIDEOS



Certified clothing according to the 2018 ESD standard. It's proved with the following tag.

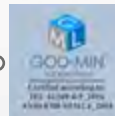

## DETAILS AND FEMALE SIZE CHART ON PAGE 112.

SIZE CHART (CM)	XS	S	M	L	XL	XXL	3XL	4XL	5XL
Sleeve	20,5	21,5	22,5	23,5	25	26,5	28	29,5	31
Length	63	66	69	72	75	78	81	84	87
Chest	100	106	112	118	124	130	136	142	148
Shoulder	41	43	45	47	49	51	54	57	60

Size tolerance (Before washing): 2%

# PGZ/F ESD POLO-SHIRT

SHORT SLEEVE, COLLAR, BREAST POCKET

## OPTIONAL

- Collar from its own fabric  
**CODE: SAA**

## FEATURES

- » Available sizes: unisex XS - 5XL, female (F) XS - 5XL
- » **Female model:** Slim style
- » Breast pocket with ESD symbol
- » Hidden snap-fasteners

## AVAILABLE FABRICS AND COLOURS

### TS15 FABRIC



### PS21 FABRIC



### TS16 FABRIC



Embroidered or printed company logo or text available upon request!  
Individual custom made ESD Clothing also available!



The given sizes are before washing.  
After washing there can be 8-10 % shrinking of the width (especially the chest)!



## ORDERING CODE

**PGZF - PS21 - RB L**  
style female fabric colour size

## DEMO VIDEOS



### DETAILS AND FEMALE SIZE CHART ON PAGE 112.

SIZE CHART (CM)	XS	S	M	L	XL	XXL	3XL	4XL	5XL
Sleeve	20,5	21,5	22,5	23,5	25	26,5	28	29,5	31
Length	63	66	69	72	75	78	81	84	87
Chest	100	106	112	118	124	130	136	142	148
Shoulder	41	43	45	47	49	51	54	57	60

Size tolerance (Before washing): 2%



Certified clothing according to the 2018 ESD standard. It's proved with the following tag.

# QGO/F ESD POLO-SHIRT

LONG SLEEVE, COLLAR, NO POCKET

## FEATURES

- » Available sizes: unisex XS - 5XL, female (F) XS - 5XL
- » **Female model:** Slim style
- » Without any pocket
- » ESD symbol on sleeve
- » Hidden snap-fasteners

## OPTIONAL

- + Collar from its own fabric  
**CODE: SAA**

## AVAILABLE FABRICS AND COLOURS

### TS15 FABRIC



### PS21 FABRIC



### TS16 FABRIC



Embroidered or printed company logo or text available upon request!  
Individual custom made ESD Clothing also available!



**The given sizes are before washing.**  
After washing there can be 8-10 % shrinking of the width (especially the chest)!

## ORDERING CODE

**QGO****F** - **PS21** - **NB** **L**  
style female fabric colour size

## DEMO VIDEOS



Certified clothing according to the 2018 ESD standard. It's proved with the following tag.



## DETAILS AND FEMALE SIZE CHART ON PAGE 112.

SIZE CHART (CM)	XS	S	M	L	XL	XXL	3XL	4XL	5XL
Sleeve	51,5	53	57	61	63	65	67	67	68
Length	63	66	69	72	75	78	81	84	87
Chest	100	106	112	118	124	130	136	142	148
Shoulder	41	43	45	47	49	51	54	57	60

Size tolerance (Before washing): 2%



# QGZ/F ESD POLO-SHIRT

LONG SLEEVE, COLLAR, BREAST POCKET

## OPTIONAL

- Collar from its own fabric  
**CODE: SAA**

## FEATURES

- Available sizes: unisex XS - 5XL, female (F) XS - 5XL
- Female model: Slim style
- Breast pocket with ESD symbol
- Hidden snap-fasteners

## AVAILABLE FABRICS AND COLOURS

### TS15 FABRIC



### PS21 FABRIC



### TS16 FABRIC



Embroidered or printed company logo or text available upon request!  
Individual custom made ESD Clothing also available!



The given sizes are before washing.  
After washing there can be 8-10 % shrinking of the width (especially the chest)!



## ORDERING CODE

**QGZF - PS21 - RB L**  
style female fabric colour size

## DEMO VIDEOS



## DETAILS AND FEMALE SIZE CHART ON PAGE 112.

SIZE CHART (CM)	XS	S	M	L	XL	XXL	3XL	4XL	5XL
Sleeve	51,5	53	57	61	63	65	67	67	68
Length	63	66	69	72	75	78	81	84	87
Chest	100	106	112	118	124	130	136	142	148
Shoulder	41	43	45	47	49	51	54	57	60

Size tolerance (Before washing): 2%



Certified clothing according to the 2018 ESD standard. It's proved with the following tag.

# TLY ESD STRETCH T-SHIRT

SHORT SLEEVE, ROUND NECK, NO POCKET

## FEATURES

- » Available sizes: unisex XS - 5XL
- » Slim style, stretch material
- » Round neck
- » Short sleeve
- » Without any pocket
- » ESD symbol on sleeve
- » Comfortable, breathable

## AVAILABLE FABRICS AND COLOURS

LY20 FABRIC

BK



Embroidered or printed company logo or text available upon request!  
Individual custom made ESD Clothing also available!

## ORDERING CODE

**TLY** - **LY20** - **BK** **L**  
style fabric colour size

DEMO VIDEO



Certified clothing according to the 2018 ESD standard. It's proved with the following tag.

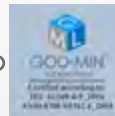

DETAILS ON PAGE 112.										
SIZE CHART (CM)	XS	S	M	L	XL	XXL	3XL	4XL	5XL	
Sleeve	19,5	20,5	21,5	22,5	23,5	25	26,5	28	29,5	
Length	56	59	62	65	68	71	74	77	80	
Chest	94	100	106	112	118	124	130	136	142	
Shoulder	39	41	43	45	47	49	51	54	57	

Size tolerance (Before washing): 2%

# RG A ESD SHORTS

- » Available sizes: Male XS - 5XL
- » Straight style
- » 2 side pockets, 1 hip pocket with
- » ESD symbol

- » 1 side pocket on the leg
- » 1 tool pocket on the leg
- » Rubberized waist with snap-fastener

## FEATURES

## AVAILABLE FABRICS AND COLOURS

KK01 FABRIC					TH55 FABRIC			CT35 FABRIC	
BK	DZ	DG	LG	W	RB	LB	W	W	
NB	RB	LB	MG	LE	TH65 FABRIC				
B	R	O	Y	LPK	W				

Embroidered or printed company logo or text available upon request!  
Individual custom made ESD Clothing also available!



## ORDERING CODE

**RG A** - **TH55** - **RB** **L**  
style fabric colour size

## DEMO VIDEO



DETAILS ON PAGE 112.

SIZE CHART (CM)	XS	S	M	L	XL	XXL	3XL	4XL	5XL
Waist	76	80	84	88	92	96	100	104	108
Hip	98	102	106	110	114	118	122	126	130
Length	59	61	63	65	67	69	71	71	71

Size tolerance (Before washing): 2%



Certified clothing according to the 2018 ESD standard. It's proved with the following tag.

# CAS ESD CARDIGAN



SHORT ZIPPER

## FEATURES

- » Available sizes: unisex XS - 5XL
- » With short zipper
- » 2 side pockets
- » ESD symbol on chest
- » ESD Cuff
- » Comfortable, breathable

## AVAILABLE FABRICS AND COLOURS

THSS FABRIC



THSB FABRIC



Embroidered or printed company logo or text available upon request!  
Individual custom made ESD Clothing also available!

DEMO VIDEO



## ORDERING CODE

**CAS** - **THSS** - **RB** **L**  
style fabric colour size

Certified clothing according to the 2018 ESD standard. It's proved with the following tag.



DETAILS ON PAGE 112-113.

SIZE CHART (CM)	XS	S	M	L	XL	XXL	3XL	4XL	5XL
Chest	108	112	116	120	124	130	136	142	148
Length	64	66	68	70	72	74	76	78	80
Sleeve	72	74	76	78	80	82	84	84	85

Size tolerance (Before washing): 2%

# CAL ESD CARDIGAN

LONG ZIPPER

## FEATURES

- » Available sizes: unisex XS - 5XL
- » With full length zipper
- » 2 side pockets
- » ESD symbol on chest
- » ESD Cuff
- » Comfortable, breathable

## AVAILABLE FABRICS AND COLOURS

THSS FABRIC



THSB FABRIC



Embroidered or printed company logo or text available upon request!  
Individual custom made ESD Clothing also available!



## ORDERING CODE

**CAL** - **THSS** - **NB** **L**  
style fabric colour size

DEMO VIDEO



DETAILS ON PAGE 112-113.

SIZE CHART (CM)	XS	S	M	L	XL	XXL	3XL	4XL	5XL
Chest	108	112	116	120	124	130	136	142	148
Length	64	66	68	70	72	74	76	78	80
Sleeve	72	74	76	78	80	82	84	84	85

Size tolerance (Before washing): 2%



Certified clothing according to the 2018 ESD standard. It's proved with the following tag.

# CAL-H ESD CARDIGAN

LONG ZIPPER, STANDING COLLAR

## FEATURES

- » Available sizes: unisex XS - 5XL
- » Standing collar
- » With full length zipper
- » 2 side pockets
- » ESD symbol on chest
- » ESD Cuff
- » Comfortable, breathable

## AVAILABLE FABRICS AND COLOURS

### THSS FABRIC



### THSB FABRIC



Embroidered or printed company logo or text available upon request!  
Individual custom made ESD Clothing also available!

## ORDERING CODE

**CAL-H** - **THSS** - **GA** **L**  
style fabric colour size

### DEMO VIDEO



DETAILS ON PAGE 112-113.

Certified clothing according to the 2018 ESD standard. It's proved with the following tag.



SIZE CHART (CM)	XS	S	M	L	XL	XXL	3XL	4XL	5XL
Chest	108	112	116	120	124	130	136	142	148
Length	64	66	68	70	72	74	76	78	80
Sleeve	72	74	76	78	80	82	84	84	85

Size tolerance (Before washing): 2%

# SWS ESD SWEATSHIRT

ROUND NECK

## FEATURES

- » Available sizes: unisex XS - 5XL
- » Round neck
- » ESD symbol on chest
- » ESD Cuff

## AVAILABLE FABRICS AND COLOURS

THSS FABRIC



THSB FABRIC



Embroidered or printed company logo or text available upon request!  
Individual custom made ESD Clothing also available!



## ORDERING CODE

**SWS** - **THSS** - **NB** **L**  
style fabric colour size

DEMO VIDEO



DETAILS ON PAGE 112-113.

SIZE CHART (CM)	XS	S	M	L	XL	XXL	3XL	4XL	5XL
Chest	108	112	116	120	124	130	136	142	148
Length	64	66	68	70	72	74	76	78	80
Sleeve	72	74	76	78	80	82	84	84	85

Size tolerance (Before washing): 2%



Certified clothing according to the 2018 ESD standard. It's proved with the following tag.

# SGS ESD SWEATSHIRT



V-NECK

## FEATURES

- » Available sizes: unisex XS - 5XL
- » V-neck
- » ESD symbol on chest
- » ESD Cuff

## AVAILABLE FABRICS AND COLOURS

THSS FABRIC



THSB FABRIC



Embroidered or printed company logo or text available upon request!  
Individual custom made ESD Clothing also available!

DEMO VIDEO



## ORDERING CODE

**SGS** - **THSS** - **NB** **L**  
style fabric colour size

Certified clothing according to the 2018 ESD standard. It's proved with the following tag.



DETAILS ON PAGE 112-113.

SIZE CHART (CM)	XS	S	M	L	XL	XXL	3XL	4XL	5XL
Chest	108	112	116	120	124	130	136	142	148
Length	64	66	68	70	72	74	76	78	80
Sleeve	72	74	76	78	80	82	84	84	85

Size tolerance (Before washing): 2%



# SGW ESD VEST

ROUND NECK

## FEATURES

- » Available sizes: unisex XS - 5XL
- » Round neck
- » ESD symbol on chest

## AVAILABLE FABRICS AND COLOURS

THSS FABRIC



THSB FABRIC



Embroidered or printed company logo or text available upon request!  
Individual custom made ESD Clothing also available!



## ORDERING CODE

**SGW** - **THSS** - **BK** **L**  
style fabric colour size

DEMO VIDEO



DETAILS ON PAGE 112-113.

SIZE CHART (CM)	XS	S	M	L	XL	XXL	3XL	4XL	5XL
Chest	100	106	112	118	124	130	136	142	148
Length	63	66	69	72	75	78	81	84	87
Shoulder	41	43	45	47	49	51	54	57	60

Size tolerance (Before washing): 2%



Certified clothing according to the 2018 ESD standard. It's proved with the following tag.

# SWW ESD VEST

V-NECK

## FEATURES

- » Available sizes: unisex XS - 5XL
- » V-neck
- » ESD symbol on chest

## AVAILABLE FABRICS AND COLOURS

THSS FABRIC



THSB FABRIC



Embroidered or printed company logo or text available upon request!  
Individual custom made ESD Clothing also available!

## ORDERING CODE

**SWW** - **THSS** - **NB** **L**  
style fabric colour size

DEMO VIDEO



Certified clothing according to the 2018 ESD standard. It's proved with the following tag.



DETAILS ON PAGE 112-113.

SIZE CHART (CM)	XS	S	M	L	XL	XXL	3XL	4XL	5XL
Chest	100	106	112	118	124	130	136	142	148
Length	63	66	69	72	75	78	81	84	87
Shoulder	41	43	45	47	49	51	54	57	60

Size tolerance (Before washing): 2%

# SWW-Z ESD VEST

V-NECK, ZIPPER

## FEATURES

- » Available sizes: unisex XS - 5XL
- » V-neck
- » With full length zipper
- » ESD symbol on chest

## AVAILABLE FABRICS AND COLOURS

### THSS FABRIC



### THSB FABRIC



Embroidered or printed company logo or text available upon request!  
Individual custom made ESD Clothing also available!



## ORDERING CODE

**SWW-Z** - **THSS** - **GA** **L**  
style fabric colour size

## DEMO VIDEO



DETAILS ON PAGE 112-113.

SIZE CHART (CM)	XS	S	M	L	XL	XXL	3XL	4XL	5XL
Chest	100	106	112	118	124	130	136	142	148
Length	63	66	69	72	75	78	81	84	87
Shoulder	41	43	45	47	49	51	54	57	60

Size tolerance (Before washing): 2%



Certified clothing according to the 2018 ESD standard. It's proved with the following tag.

# WJ ESD WINTER JACKET



STANDING COLLAR

## FEATURES

- » Available sizes: unisex XS - 5XL
- » With fleece lining
- » Water-repellent outer layer
- » ESD symbol on chest
- » 2 side pockets
- » Hidden zipper

## AVAILABLE FABRICS AND COLOURS

WC10 FABRIC

NB



Embroidered or printed company logo or text available upon request!  
Individual custom made ESD Clothing also available!



DEMO VIDEO



## ORDERING CODE

**WJ** - **WC10** - **NB** **L**  
 style fabric colour size

DETAILS ON PAGE 112-113.

Certified clothing according to the 2018 ESD standard. It's proved with the following tag.



SIZE CHART (CM)	XS	S	M	L	XL	XXL	3XL	4XL	5XL
Chest	124	128	132	136	140	144	148	152	156
Sleeve	62	63	64	65	68	68	69	69	70
Length	78	79	80	81	82	83	84	85	86

Size tolerance (Before washing): 2%

# WW ESD WINTER VEST

STANDING COLLAR

## FEATURES

- » Available sizes: unisex XS - 5XL
- » With fleece lining
- » Water-repellent outer layer
- » ESD symbol on chest
- » 2 side pockets
- » Hidden zipper

## AVAILABLE FABRICS AND COLOURS

WC10 FABRIC

NB

Embroidered or printed company logo or text available upon request!  
Individual custom made ESD Clothing also available!



## ORDERING CODE

**WW** - **WC10** - **NB** **L**  
style fabric colour size

**NEW  
DESIGN**

DEMO VIDEO



DETAILS ON PAGE 112-113.

SIZE CHART (CM)	XS	S	M	L	XL	XXL	3XL	4XL	5XL
Chest	124	128	132	136	140	144	148	152	156
Length	70	71	72	73	74	75	76	77	78

Size tolerance (Before washing): 2%



Certified clothing according to the 2018 ESD standard. It's proved with the following tag.

# WN ESD WINTER TROUSERS WITH BRIDLES



## FEATURES

- » Available sizes: unisex XS - 5XL
- » With fleece lining
- » Water-repellent outer layer
- » 2 side pockets, 1 breast pocket with ESD symbol
- » 2 side pockets on legs
- » 2 quick release buckles

## AVAILABLE FABRICS AND COLOURS

### WC10 FABRIC



DEMO VIDEO



Embroidered or printed company logo or text available upon request!  
Individual custom made ESD Clothing also available!

## ORDERING CODE

**WN** - **WC10** - **NB** **L**  
style fabric colour size

Certified clothing according to the 2018 ESD standard. It's proved with the following tag.



DETAILS ON PAGE 112-113.

SIZE CHART (CM)	XS	S	M	L	XL	XXL	3XL	4XL	5XL
Length external	104	106	108	110	112	114	116	118	119
Hip	102	107	111	115	119	123	128	132	136
Bridle length	62	63	64	64	66	66	68	68	70

Size tolerance (Before washing): 2%

# SKS ESD HOODIED SWEATSHIRT

## FEATURES

- » Available sizes: unisex XS - 5XL
- » Hood with strings
- » With ESD Symbol on sleeve
- » ESD Cuff
- » 2 side pockets

## AVAILABLE FABRICS AND COLOURS

### THSS FABRIC



### THSB FABRIC



Embroidered or printed company logo or text available upon request!  
Individual custom made ESD Clothing also available!



## ORDERING CODE

**SKS** - **THSS** - **BK L**  
style fabric colour size

## DEMO VIDEO



DETAILS ON PAGE 112-113.

SIZE CHART (CM)	XS	S	M	L	XL	XXL	3XL	4XL	5XL
Sleeve	52	53	57	61	63	65	67	67	68
Length	64	66	68	70	72	74	76	76	76
Chest	100	106	112	118	124	130	136	142	148
Shoulder	41	43	45	47	49	51	54	57	60

Size tolerance (Before washing): 2%



Certified clothing according to the 2018 ESD standard. It's proved with the following tag.

# VES-S ESD QUILTED VEST



V-NECK

## FEATURES

- » Available sizes: unisex XS - 5XL
- » With quilted lining
- » Hidden snap-fasteners
- » ESD symbol on chest
- » 2 side pockets
- » Not waterproof

## AVAILABLE FABRICS AND COLOURS

CT35 FABRIC

W



Embroidered or printed company logo or text available upon request!  
Individual custom made ESD Clothing also available!

DEMO VIDEO



## ORDERING CODE

**VES-S** - **CT35** - **W L**  
style fabric colour size

DETAILS ON PAGE 112-113.

Certified clothing according to the 2018 ESD standard. It's proved with the following tag.



SIZE CHART (CM)	XS	S	M	L	XL	XXL	3XL	4XL	5XL
Chest	102	110	118	126	132	138	144	150	154
Length	64	66	68	70	72	74	76	78	80

Size tolerance (Before washing): 2%



# VES-H ESD QUILTED VEST

ZIPPER, STANDING COLLAR

## FEATURES

- » Available sizes: unisex XS - 5XL
- » With quilted lining
- » With zipper
- » ESD symbol on chest
- » 2 side pockets
- » Not waterproof

## AVAILABLE FABRICS AND COLOURS

CT35 FABRIC

W

Embroidered or printed company logo or text available upon request!  
Individual custom made ESD Clothing also available!



## ORDERING CODE

**VES-H** - **CT35** - **W L**  
style fabric colour size

DEMO VIDEO



DETAILS ON PAGE 112-113.

SIZE CHART (CM)	XS	S	M	L	XL	XXL	3XL	4XL	5XL
Chest	102	110	118	126	132	138	144	150	154
Length	64	66	68	70	72	74	76	78	80

Size tolerance (Before washing): 2%



Certified clothing according to the 2018 ESD standard. It's proved with the following tag.

# VES-T ESD WEST



QUILTED LINING

## FEATURES

- » Available sizes: unisex XS – 5XL
- » With quilted lining (white)
- » With zipper
- » ESD symbol on chest
- » 2 side pockets
- » Not waterproof, for indoor use

## AVAILABLE FABRICS AND COLOURS

KK01 FABRIC					TH55 FABRIC			CR10HI FABRIC		WC10 FABRIC
BK	DZ	DG	LG	W	RB	LB	W	O	Y	NB
NB	RB	LB	MG	LE	CR10 FABRIC			CT35 FABRIC		
B	R	O	Y	LPK	LB	W	W			



Embroidered or printed company logo or text available upon request!  
Individual custom made ESD Clothing also available!

DEMO VIDEO



## ORDERING CODE

**VES-T - KK01 - B L**  
style fabric colour size

Certified clothing according to the 2018 ESD standard. It's proved with the following tag.



DETAILS ON PAGE 112.

SIZE CHART (CM)	XS	S	M	L	XL	XXL	3XL	4XL	5XL
Length	63	65	67	69	71	73	75	76	77
Chest	90	98	106	114	122	130	136	142	148
Shoulder	40	43	46	49	52	55	58	61	65

Size tolerance (Before washing): 2%

# FCU ESD FLEECE CARDIGAN

LONG ZIPPER AND COLOURED INSERTS

## FEATURES

- » Available sizes: unisex XS – 5XL
- » With coloured inserts: **CR10HI-O or Y**
- » With zipper
- » Standing collar
- » ESD symbol on sleeve
- » 2 side pockets, 1 breast pocket for identity card
- » Not waterproof, for indoor use

## AVAILABLE FABRICS AND COLOURS

### FL1 FABRIC



### FOR COLOURED INSERTS

### CR10HI FABRIC



Embroidered or printed company logo or text available upon request!  
Individual custom made ESD Clothing also available!

## ORDERING CODE

**FCU** - **FL1** - **BK** / **Y** **L**  
style fabric colour coloured insert size

### DEMO VIDEO



Certified clothing according to the 2018 ESD standard. It's proved with the following tag.



DETAILS ON PAGE 112.

SIZE CHART (CM)	XS	S	M	L	XL	XXL	3XL	4XL	5XL
Chest	102	106	110	114	118	122	126	130	134
Length	85	88	71	74	77	80	83	86	89
Sleeve	55	57	59	61	63	65	67	67	68
Shoulder	42	43	44	45	46	47	48	49	49

Size tolerance (Before washing): 2%

# FCF ESD FEMALE FLEECE CARDIGAN

LONG ZIPPER AND COLOURED INSERTS

## FEATURES

- » Available sizes: female XS – 5XL
- » With coloured inserts: **CR10HI-O or Y**
- » With zipper
- » Standing collar
- » ESD symbol on sleeve
- » 2 side pockets, 1 breast pocket for identity card
- » Not waterproof, for indoor use

## AVAILABLE FABRICS AND COLOURS

### FL1 FABRIC



### FOR COLOURED INSERTS

### CR10HI FABRIC



Embroidered or printed company logo or text available upon request!  
Individual custom made ESD Clothing also available!



## ORDERING CODE

**FCF** - **FL1** - **NB** / **O** **L**  
 style fabric colour coloured insert size

## DEMO VIDEO



DETAILS ON PAGE 112.

SIZE CHART (CM)	XS	S	M	L	XL	XXL	3XL	4XL	5XL
Chest	102	106	110	114	118	122	126	130	134
Length	62	65	68	71	74	77	80	83	83
Sleeve	55	57	59	61	63	65	67	67	68
Shoulder	42	43	44	45	46	47	48	49	49

Size tolerance (Before washing): 2%



Certified clothing according to the 2018 ESD standard. It's proved with the following tag.

# FBU ESD FLEECE CARDIGAN

LONG ZIPPER AND INSIDE COLOURED COLLAR

## FEATURES

- » Available sizes: unisex XS – 5XL
- » with coloured inserts
- » With zipper
- » Standing collar
- » ESD symbol on sleeve
- » 2 side pockets
- » Not waterproof, for indoor use

## AVAILABLE FABRICS AND COLOURS

### FL1 FABRIC



### FOR COLOURED INSERTS

### FL1 FABRIC



Embroidered or printed company logo or text available upon request!  
Individual custom made ESD Clothing also available!

## ORDERING CODE

**FBU** - **FL1** - **NB** / **Y** **L**  
style fabric colour coloured insert size

### DEMO VIDEO



Certified clothing according to the 2018 ESD standard. It's proved with the following tag.



DETAILS ON PAGE 112.

SIZE CHART (CM)	XS	S	M	L	XL	XXL	3XL	4XL	5XL
Chest	102	106	110	114	118	122	126	130	134
Length	85	88	71	74	77	80	83	86	89
Sleeve	55	57	59	61	63	65	67	67	68
Shoulder	42	43	44	45	46	47	48	49	49

Size tolerance (Before washing): 2%

# FBF ESD FEMALE FLEECE CARDIGAN

LONG ZIPPER AND INSIDE COLOURED COLLAR

## FEATURES

- » Available sizes: female XS – 5XL
- » With coloured inserts
- » With zipper
- » Standing collar
- » ESD symbol on sleeve
- » 2 side pockets
- » Not waterproof, for indoor use

## AVAILABLE FABRICS AND COLOURS

### FOR COLOURED INSERTS

#### FL1 FABRIC



#### FL1 FABRIC



Embroidered or printed company logo or text available upon request!  
Individual custom made ESD Clothing also available!



## ORDERING CODE

**FBF** - **FL1** - **NB** / **O** **L**  
 style fabric colour coloured insert size

### DEMO VIDEO



DETAILS ON PAGE 112.

SIZE CHART (CM)	XS	S	M	L	XL	XXL	3XL	4XL	5XL
Chest	102	106	110	114	118	122	126	130	134
Length	62	65	68	71	74	77	80	83	83
Sleeve	55	57	59	61	63	65	67	67	68
Shoulder	42	43	44	45	46	47	48	49	49

Size tolerance (Before washing): 2%



Certified clothing according to the 2018 ESD standard. It's proved with the following tag.

# FSU ESD FLEECE CARDIGAN



LONG ZIPPER

## FEATURES

- » Available sizes: unisex XS – 5XL
- » With zipper
- » Standing collar
- » ESD symbol on sleeve
- » 2 side pockets, 1 breast pocket for identity card
- » Not waterproof, for indoor use

## AVAILABLE FABRICS AND COLOURS

FL1 FABRIC



Embroidered or printed company logo or text available upon request!  
Individual custom made ESD Clothing also available!

DEMO VIDEO



## ORDERING CODE

**FSU** - **FL1** - **DG** **L**  
style fabric colour size

Certified clothing according to the 2018 ESD standard. It's proved with the following tag.



DETAILS ON PAGE 112.

SIZE CHART (CM)	XS	S	M	L	XL	XXL	3XL	4XL	5XL
Chest	102	106	110	114	118	122	126	130	134
Length	85	88	71	74	77	80	83	86	89
Sleeve	55	57	59	61	63	65	67	67	68
Shoulder	42	43	44	45	46	47	48	49	49

Size tolerance (Before washing): 2%

# FFF ESD FEMALE FLEECE CARDIGAN

LONG ZIPPER

## FEATURES

- » Available sizes: unisex XS – 5XL
- » With zipper
- » Standing collar
- » ESD symbol on sleeve
- » Side pockets, 1 breast pocket for identity card
- » Not waterproof, for indoor use

## AVAILABLE FABRICS AND COLOURS

FL1 FABRIC



Embroidered or printed company logo or text available upon request!  
Individual custom made ESD Clothing also available!



## ORDERING CODE

**FFF** - **FL1** - **O** **L**  
style fabric colour size

DEMO VIDEO



DETAILS ON PAGE 112.

SIZE CHART (CM)	XS	S	M	L	XL	XXL	3XL	4XL	5XL
Chest	102	106	110	114	118	122	126	130	134
Length	62	65	68	71	74	77	80	83	83
Sleeve	55	57	59	61	63	65	67	67	68
Shoulder	42	43	44	45	46	47	48	49	49

Size tolerance (Before washing): 2%



Certified clothing according to the 2018 ESD standard. It's proved with the following tag.



# WH ESD WINTER HAT



## FEATURES

- » Available sizes: Unisex, one size
- » With ESD Symbol
- » Comfortable
- » Warm and breathable

## AVAILABLE FABRICS AND COLOURS

### PS21 FABRIC



### FL1 FABRIC



Embroidered or printed company logo or text available upon request!  
Individual custom made ESD Clothing also available!

## ORDERING CODE

**WH** - **PS21** - **NB**  
style fabric colour

## DEMO VIDEO



Certified clothing according to the 2018 ESD standard. It's proved with the following tag.



# WS ESD SCARF

## FEATURES

- » Available sizes: Unisex, one size
- » With ESD Symbol
- » Comfortable
- » Warm and breathable

## AVAILABLE FABRICS AND COLOURS

### FL1 FABRIC



### PS21 FABRIC



Embroidered or printed company logo or text available upon request!  
Individual custom made ESD Clothing also available!



## DEMO VIDEO



## ORDERING CODE

**WS** - **PS21** - **NB**  
style fabric colour



Certified clothing according to the 2018 ESD standard. It's proved with the following tag.



UTB ESD UTILITY BAG



PKTT ESD BOTTLE HOLDER

INDIVIDUAL CUSTOM MADE ESD CLOTHING AND PRODUCTS ALSO AVAILABLE



BUM ESD BELT BAG



KV1 ESD ARM COVER

**NH ESD  
WASHABLE HAIR NET**



**BPK CAP WITH  
BUN HOLDER**



○ **INDIVIDUAL CUSTOM MADE ESD CLOTHING  
AND PRODUCTS ALSO AVAILABLE** ○

**COVER ESD COVER**



**CURT ESD CURTAIN**



# COV CLEANROOM COVERALL



## FEATURES

- » Double covered front zipper
- » Adjustable waistband inside
- » Standing collar with push buttons
- » Raglan arm shape
- » Conductive knitted cuffs at arms and legs

## OPTIONAL

- + Chest, hip or bottom pockets
- + Pen, identity card loops
- + Company logos

## AVAILABLE FABRICS AND COLOURS

### CR10 FABRIC



Individual custom made ESD Clothing also available!

## ORDERING CODE

**COV** - **CR10** - **LB** **L**  
 style fabric colour size

### DEMO VIDEO



Certified clothing according to the 2018 ESD standard. It's proved with the following tag.



DETAILS ON PAGE 114.

SIZE CHART (CM)	3XS	XXS	XS	S	M	L	XL	XXL	3XL	4XL
Bust girth	113,5	119,0	125,5	131,5	135,5	143,0	151,5	155,0	160,0	166,0
Waist grith	90,0	93,5	99,0	103,5	109,0	116,5	124,5	133,0	140,0	150,0
Hip girth	106,0	111,0	114,0	119,0	122,0	128,0	136,0	150,0	155,0	162,0
Length of back	51,0	54,0	55,0	55,5	58,0	60,0	62,0	64,5	70,0	75,0
Length at the side	99,5	103,0	105,5	107,0	112,0	119,0	124,0	127,0	135,5	139,0
Length of stride	70,5	73,5	75,0	77,0	79,0	86,0	91,0	94,5	100,0	103,0
Sleeve-length downside	49,0	50,0	52,0	53,5	56,0	57,5	60,0	61,0	62,0	63,0
Tigh girth	59,0	61,0	63,0	66,0	70,0	72,0	76,0	79,0	82,0	86,0
Perimeter of upper arm	39,0	42,0	45,0	49,0	50,0	53,5	56,0	57,0	58,0	60,0
Sleeve / sholder length upside	74,0	75,0	76,0	79,0	80,0	82,0	85,0	86,0	88,0	90,0

Size tolerance (Before washing): 3%; shrinkage by decontamination: 3-5%

# COVH CLEANROOM COVERALL

## OPTIONAL

- + Chest, hip or bottom pockets
- + Pen, identity card loops
- + Company logos
- » Double covered front zipper
- » Adjustable waistband inside
- » Press buttons at neck
- » Raglan arm shape
- » Conductive knitted cuffs at arms and legs
- » Open face
- » Adjustable by press buttons at the back of hood
- » Snap-fasteners for face-mask

WITH INTEGRATED HOOD

## FEATURES

## AVAILABLE FABRICS AND COLOURS

CR10 FABRIC

LB

W

Individual custom made ESD Clothing also available!



## ORDERING CODE

**COVH** - **CR10** - **W L**  
 style fabric colour size

DEMO VIDEO



DETAILS ON PAGE 114.

SIZE CHART (CM)	3XS	XXS	XS	S	M	L	XL	XXL	3XL	4XL
Chest/bust measurement	113,5	119,0	125,5	131,5	135,5	143,0	151,5	155,0	160,0	166,0
Waist measurement	90,0	93,5	99,0	103,5	109,0	116,5	124,5	133,0	140,0	150,0
Bottom measurement	106,0	111,0	114,0	119,0	122,0	128,0	136,0	150,0	155,0	162,0
Waist lenght (back)	49,0	52,0	53,0	53,5	56,0	58,0	60,0	62,5	68,0	71,0
Length at the side	99,5	103,0	105,5	107,0	112,0	119,0	124,0	127,0	135,5	143,0
Length of stride	70,5	73,5	75,0	77,0	79,0	86,0	91,0	94,5	100,0	103,0
Lower lenght of arm	49,0	50,0	52,0	53,5	56,0	57,5	60,0	61,0	62,0	63,0
Perimeter of upper leg	59,0	61,0	63,0	66,0	70,0	72,0	76,0	79,0	82,0	86,0
Perimeter at height of forehead	60,0	60,0	60,0	61,0	63,0	65,0	68,0	71,0	74,0	77,0
Perimeter face openingg	76,0	77,0	78,0	80,0	82,0	84,0	86,0	88,0	90,0	92,0

Size tolerance (Before washing): 3%; shrinkage by decontamination: 3-5%



Certified clothing according to the 2018 ESD standard. It's proved with the following tag.



# COA CLEANROOM COAT



## FEATURES

- » Double covered front zipper
- » Standing collar with push buttons
- » Raglan arm shape
- » Conductive knitted cuffs at arms
- » Extra long coat

## OPTIONAL

- + Chest, hip or bottom pockets
- + Adjustable waistband inside
- + Pen, identity card loops
- + Company logos

## AVAILABLE FABRICS AND COLOURS

### CR10 FABRIC



Individual custom made ESD Clothing also available!

## ORDERING CODE

**COA - CR10 - LB L**  
 style fabric colour size

### DEMO VIDEO



Certified clothing according to the 2018 ESD standard. It's proved with the following tag.



DETAILS ON PAGE 114.

SIZE CHART (CM)	3XS	XXS	XS	S	M	L	XL	XXL	3XL	4XL
Chest/bust measurement	113,5	119,0	125,5	131,5	135,5	143,0	151,5	155,0	160,0	166,0
Waist measurement	105,5	109,0	115,0	117,0	126,0	131,5	138,0	143,5	150,0	160,0
Bottom measurement	113,0	117,0	121,0	123,5	131,0	140,5	145,5	150,0	155,0	162,0
Length of back part	109,0	111,0	113,0	114,5	119,0	124,0	125,5	125,5	125,5	125,5
Sleeve-length downside	49,0	50,0	52,0	53,5	56,0	57,5	60,0	61,0	61,0	63,0
Perimeter of neck	39,0	40,5	41,5	43,0	44,0	45,5	51,0	52,0	54,0	55,0
Perimeter of upper arm	41,0	44,0	46,5	49,0	50,5	53,0	56,0	57,0	58,5	61,5
Sleeve / sholder length upside	73,0	75,0	77,0	80,0	82,5	83,5	86,0	87,5	88,0	90,5

Size tolerance (Before washing): 3%; shrinkage by decontamination: 3-5%

# JAC CLEANROOM JACKET AND TRU TROUSERS

## JACKET FEATURES

- » Front zipper
- » Standing collar with push buttons
- » Raglan arm shape
- » Conductive knitted cuffs at arms

## OPTIONAL

- + Chest, hip or bottom pockets
- + Pen, identity card loops
- + Company logos

## ORDERING CODE

**JAC - CR10 - W L**  
 style fabric colour size

## TROUSERS FEATURES

- » Adjustable waistband
- » Conductive knitted cuffs at the legs

## OPTIONAL

- + Pockets
- + Company logos

## ORDERING CODE

**TRU - CR10 - W L**  
 style fabric colour size

## AVAILABLE FABRICS AND COLOURS

CR10 FABRIC

LB

W

DETAILS ON PAGE 115.

JAC CLEANROOM JACKET	3XS	XXS	XS	S	M	L	XL	XXL	3XL	4XL
Chest/bust measurem	106,0	109,0	112,0	116,0	124,0	131,0	136,0	141,0	146,0	154,0
Waist measurement	99,0	102,0	105,0	109,0	117,0	124,0	129,0	134,0	139,0	147,0
Perim. of lower border	115,0	118,0	121,0	125,0	133,0	140,0	145,0	150,0	155,0	163,0
Length of back part	73,5	75,5	78,5	81,5	85,5	88,0	90,0	92,5	94,0	94,0
Lower length of arm	52,0	53,0	54,0	55,5	58,5	58,5	59,5	60,0	60,0	61,0
Perimeter of neck	45,0	46,5	47,5	48,0	50,0	55,0	57,0	59,0	59,0	59,0
TRU CLEANROOM TROUSERS	3XS	XXS	XS	S	M	L	XL	XXL	3XL	4XL
Waist perimeter gathered	75,0	78,0	80,0	83,0	87,0	90,0	99,0	103,0	107,0	114,0
Waist perimeter stretched	98,0	102,0	104,0	108,0	113,0	116,0	128,0	133,0	138,0	146,0
Bottom perimeter	108,0	111,0	114,0	118,0	120,0	123,0	133,0	138,0	143,0	149,0
Length at the side	103,0	105,0	107,0	110,5	113,0	116,0	121,0	125,0	127,0	131,0
Length of stride	74,0	75,5	78,0	80,0	82,0	84,5	88,0	90,0	92,0	94,0
Thigh width	58,0	59,0	61,0	62,0	63,0	66,0	71,0	74,0	78,0	82,0

Size tolerance (Before washing): 3%; shrinkage by decontamination: 3-5%

DEMO VIDEO



Certified clothing according to the 2018 ESD standard. It's proved with the following tag.



Individual custom made ESD Clothing also available!





# FCH CLEANROOM FULL COVER HOOD



## FEATURES

- » Front zipper
- » Flat top
- » Adjustable by press buttons behind
- » Open face
- » Snap-fasteners for face-mask

## OPTIONAL

- + Company logos

## AVAILABLE FABRICS AND COLOURS

### CR10 FABRIC



Individual custom made ESD Clothing also available!

## ORDERING CODE

**FCH** - **CR10** - **LB** **L**  
 style fabric colour size

## DEMO VIDEO



Certified clothing according to the 2018 ESD standard. It's proved with the following tag.



DETAILS ON PAGE 115.

SIZE CHART (CM)	XXS	XS	S	M	L	XL	XXL
E	23,5	24,5	26,0	26,0	28,5	28,5	28,5
H	13,0	14,0	15,0	16,0	17,0	17,0	17,0
A1	52,0	55,0	58,0	61,0	63,5	66,0	69,0
G	6,0	6,0	6,0	6,0	6,5	6,5	6,5
S	21,0	21,0	21,0	21,0	21,0	21,0	21,0

Size tolerance (Before washing): 3%; shrinkage by decontamination: 3-5%

# FMS CLEANROOM FACE MASK

## FEATURES

- › Fastening on full cover hood with press buttons
- › Can't be used separately
- › Only with COVH or FCH

## AVAILABLE FABRICS AND COLOURS

### CR10 FABRIC

LB

W

Individual custom made ESD Clothing also available!



## DEMO VIDEO



## ORDERING CODE

**FMS** - **CR10** - **W** **L**  
 style fabric colour size



DETAILS ON PAGE 115.

SIZE CHART (CM)	Size
A	25,0
B	6,0
C	31,0
D	30,0



Certified clothing according to the 2018 ESD standard. It's proved with the following tag.

Size tolerance (Before washing): 3%; shrinkage by decontamination: 3-5%

# STG CLEANROOM SHOES

WITH TEXTILE GAITER

## FEATURES

- » Front zipper
- » Comfortable shoes
- » Conductive soles
- » Adjustable ribbon with velcro

## AVAILABLE FABRICS AND COLOURS

CR10 FABRIC

W



Individual custom made ESD Clothing also available!

## ORDERING CODE

**STG** - **CR10** - **W 41**  
style fabric colour size

## DEMO VIDEO



Certified clothing according to the 2018 ESD standard. It's proved with the following tag.



### SIZE CHART (CM)

36	37,5	38,5	40	41	42	43	44,5	45,5	46,5
----	------	------	----	----	----	----	------	------	------

Size tolerance (Before washing): 3%; shrinkage by decontamination: 3-5%

PGO PGZ TGO TGZ

TKO TKZ TLY

○ DESCRIPTION

1. Sleeve
2. Chest
3. Length
4. Shoulder

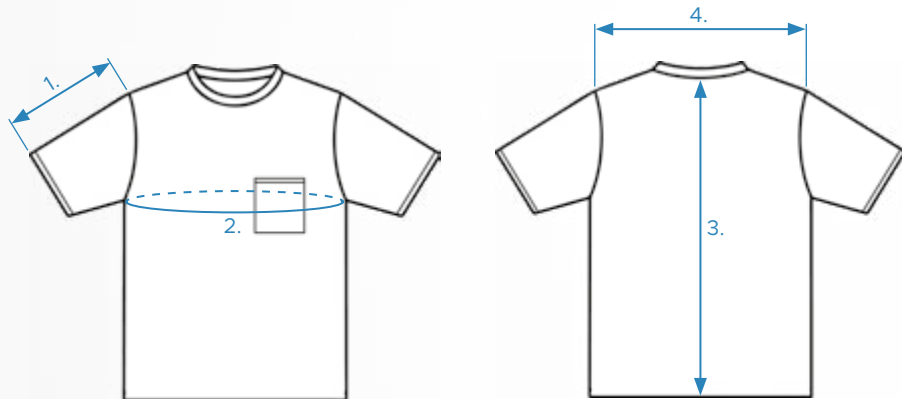

FEMALE SHORT SLEEVE

SIZE CHART (CM)	XS	S	M	L	XL	XXL	3XL	4XL	5XL
Sleeve	20	21	22,5	23,5	25,5	27,5	28	30	31,5
Length	63	66	69	72	75	78	81	84	87
Chest	82	86	91	96	102	110	114	118	122
Waist	66	70	75	80	86	94	98	104	108
Hip	90	94	99	105	111	117	123	129	135
Shoulder	39	40	41	42	43	44	45	46	47

CAL CAS LGO LGZ LKO LKZ

QGO QGZ SGS SKS SWS WJ

FCU FCF FBU FBF FSU FFF

○ DESCRIPTION

1. Sleeve
2. Chest
3. Length
4. Shoulder

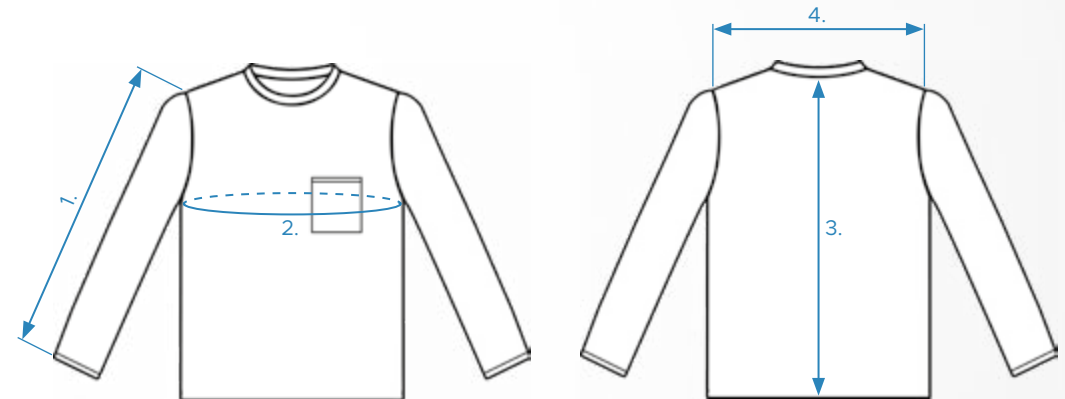

FEMALE LONG SLEEVE

SIZE CHART (CM)	XS	S	M	L	XL	XXL	3XL	4XL	5XL
Sleeve	51	52,5	56,5	60,5	62,5	64,5	66,5	66,5	67,5
Length	63	66	69	72	75	78	81	84	87
Chest	82	86	91	96	102	110	114	118	122
Waist	66	70	75	80	86	94	98	104	108
Hip	90	94	99	105	111	117	123	129	135
Shoulder	39	40	41	42	43	44	45	46	47

**EFL EFS EFX ESL ESS ESX OJ**  
**PF1 PS1 PF2 PS2 PF3 PS3**

**DESCRIPTION**

- 1. Chest
- 2. Shoulder
- 3. Sleeve
- 4. Length
- 5. Cuff
- 6. Hip

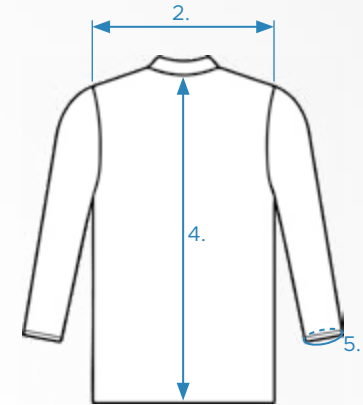
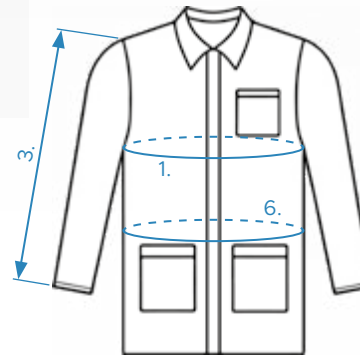

**HIV SGW SWW**  
**VES-H VES-S VES-T WW**

**DESCRIPTION**

- 1. Chest
- 2. Length
- 3. Shoulder

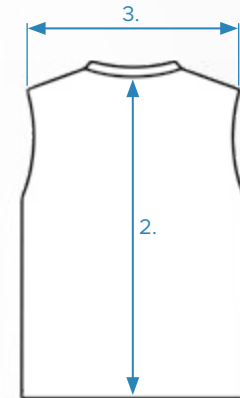
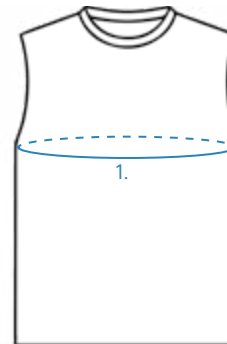

**ET ETF NT NTF**  
**OT RGA WN**

**DESCRIPTION**

- 1. Waist
- 2. Hip
- 3. Length external

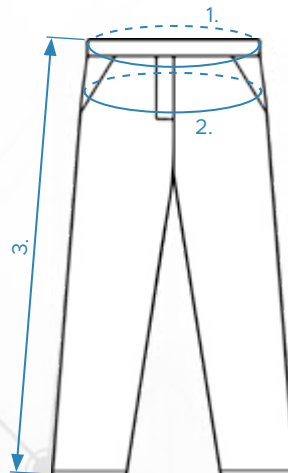

**SKI**

**DESCRIPTION**

- 1. Waist
- 2. Hip
- 3. Length

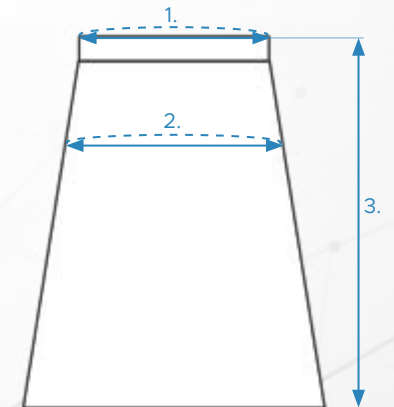

**COV COVH**

**DESCRIPTION**

- |                           |                                     |
|---------------------------|-------------------------------------|
| 1. Bust girth             | 8. Tigh girth                       |
| 2. Waist grith            | 9. Perimeter of upper arm           |
| 3. Hip girth              | 10. Sleeve / sholder length upside  |
| 4. Length of back         | 11. Perimeter at height of forehead |
| 5. Length at the side     | 12. Perimeter face openingg         |
| 6. Length of stride       |                                     |
| 7. Sleeve-length downside |                                     |

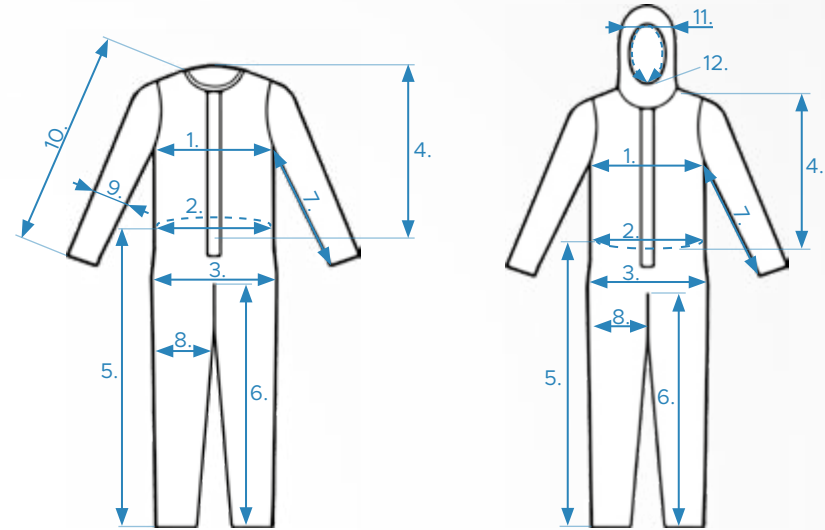

**COA**

**DESCRIPTION**

- |                           |                                   |
|---------------------------|-----------------------------------|
| 1. Chest/bust measurement | 5. Sleeve-length downside         |
| 2. Waist measurement      | 6. Perimeter of neck              |
| 3. Bottom measurement     | 7. Perimeter of upper arm         |
| 4. Length of back part    | 8. Sleeve / sholder length upside |

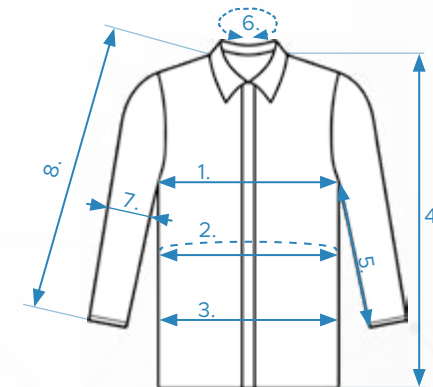

# JAC TRU

## DESCRIPTION

1. Chest/bust measurem
2. Waist measurement
3. Perimeter of lower border
4. Length of back part
5. Lower length of arm
6. Perimeter of neck

1. Waist perimeter gathered
2. Waist perimeter stretched
3. Bottom perimeter
4. Length at the side

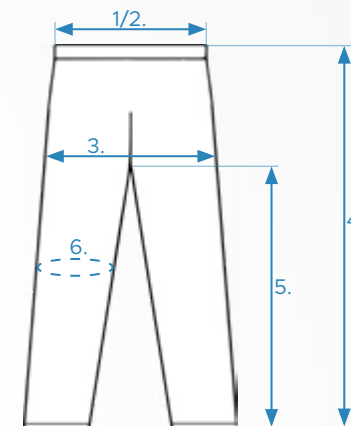
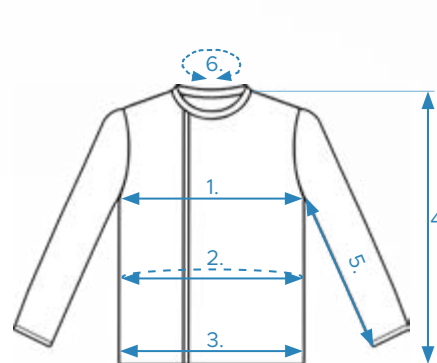

## FCH

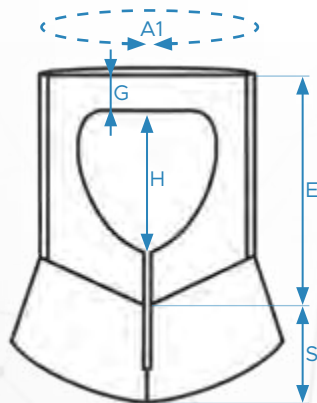

## FMS

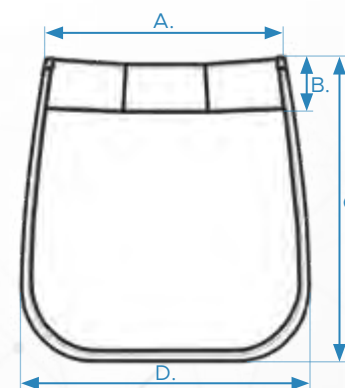



# LOGO DESIGN

---

There is a possibility to give an individual look to our garments with your company logo. High quality embroidery or printing are also available.

Please send your logo in \*.jpg format via e-mail, we will prepare our offer to you.