

TTP™



Labels for Life.

THERMAL TRANSFER PRODUCTS



www.identco.com
EUROPE PRODUCT PORTFOLIO

IDENTCO partners with industrial, transportation, and electronics customers across the globe to develop high performance labeling solutions that outlast the products they identify. We have a singular focus: labeling solutions. Adopting this singular focus has allowed us to develop and refine our processes over the past 30 years, and become leaders in collaborative, technology driven solutions.

IDENTCO TTP™ solutions offer optimal labels, ribbons, and equipment for your company's on-demand identification needs.

TTP™ – THERMAL TRANSFER PRODUCTS

- Stock Blank Labels
- Custom Blank and Pre-printed Labels
- Labels for Automatic Placement Equipment
- Thermal Transfer Ribbons
- Thermal Transfer Printers & Label Software
- Scanners, Rewinders, Dispensers, & SMT Label Feeders



CPP™ – CUSTOM PRINTED PRODUCTS

- Brand Recognition Labels
- Graphic Overlays
- **UL / CSA** Nameplates
- Information & Instructional Labels
- Security & Anti-Counterfeiting Labels



DCP™ – DIE CUT PRODUCTS

- Protective Masks & Lenses
- Adhesives & Bonding
- Insulators
- Custom Engineered Products



WMP™ – WIRE MARKING PRODUCTS

- Heat Shrink Sleeves (formatted and continuous)
- Self-laminating Cable Identification Labels
- Print-protected Labels
- Flag Wire Markers



TTP PRODUCT PORTFOLIO 1000-100-0117
(In Mexico, please refer to iMexico TTP
Product Portfolio)

TTP™

THERMAL TRANSFER PRODUCTS





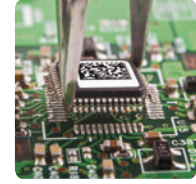





















Labels for Life.



| | | |
|--|---|-------|
| Material Reference | TTP: Thermal Transfer Label Materials | 2 |
| Label Reference Guide | Standard Label Configuration & Terms | 3 |
| Circuit Board & Electronic Component Labels | TTL™ 100 Series | 4 |
| TTL™ 100 Series Product Specifications | Illustrations & Reference: TTL™ 100-149 | 5-17 |
| Wire & Cable Identification Labels | TTL™ 200 Series | 18 |
| TTL™ 200 Series Product Specifications | Illustrations & Reference: TTL™ 200-210 | 19-22 |
| Packaging & Shipping Labels | TTL™ 1-14 Series | 23 |
| UL/CSA Nameplate Labels | TTL™ 300 Series | 24 |
| TTL™ 300 Series Product Specifications | Illustrations & Reference: TTL™ 300-312 | 25-28 |
| Print Protection | GraphicLock™ TT for Thermal Transfer Printing | 29 |
| Thermal Transfer Ribbons | TTRR™ Series: Resin & Wax/Resin Combination Ribbons | 30 |
| Thermal Transfer Ribbons | TTR™ Series: Wax Ribbons | 31 |
| Print Service Bureau | Variable Printing Alternative | 32 |
| Custom Blank Labels | Special Shapes, Sizes & Die Cuts | 33 |
| Thermal Transfer Printers | ELP™ Series | 34 |
| Thermal Transfer Printers | ELP™ Series Model Comparisons | 35 |
| ELP-A™ Print & Apply Applicator | IDENTCO ELP-A™ Series | 36 |
| Precision Labels for Automatic Applications | Auto-Apply Labels | 37 |
| Automation Equipment | Pre-printed Label Presenter | 38 |
| IMS Series Heat Shrink Wire Markers | Visual Data Management for Tough Environments | 39 |
| Assume Quality, Expect Perfection | Highest Quality Global Production | 40 |

MATERIAL REFERENCE

TTP: THERMAL TRANSFER LABEL MATERIALS

| | MATERIAL | COLOR | FINISH | TEMPERATURE RANGE | MATERIAL DESCRIPTION | RECOMMENDED RIBBON | AUTO APPLY | AGENCY RECOGNITION* |
|---------------|----------|--------|------------|----------------------------------|--|--------------------|------------|---|
| POLYIMIDE | TT403 | White | Gloss | -40°F to 572°F -40°C to 300°C | High temperature film designed for top-side, bottom-side identification labels that are exposed to high temperatures and lead-free solder used primarily in the PCBA industry. | TTRR-B TTRR-D | • |  |
| | TT403GR | Green | Gloss | -40°F to 572°F -40°C to 300°C | Green was designed to indicate lead-free applications. Ideal for high temperatures, lead-free solder, bottom side of boards. | TTRR-B TTRR-D | • |  |
| | TT411 | Tan | Matte | -40°F to 572°F -40°C to 300°C | High temp film designed for top-side, bottom-side identification labels that are exposed to high temperatures and lead-free solder used primarily in the PCBA industry. (Must use TTRR™AK ribbon.) | TTRR-AK | • |  |
| | TT416 | White | Gloss | -40°F to 572°F -40°C to 300°C | High temperatures, lead-free solder top and bottom side of boards. | TTRR-B TTRR-D | • |  |
| | TT417 | White | Matte | -40°F to 572°F -40°C to 300°C | High temperatures, lead-free solder top and bottom side of boards. | TTRR-B TTRR-D | • |  |
| | TT433 | White | Gloss | -40°F to 572°F -40°C to 300°C | Ultra solvent resistant high temperature film. Withstands the new aggressive cleaning agents from KYZEN® and ZESTRON® for in-line and batch washing process. Use TTRR™CR ribbon for top performance. | TTRR-CR | • |  |
| | TT451 | White | Semi-Gloss | -40°F to 572°F -40°C to 300°C | ESD / Static dissipative top coat. Ideal for high temperatures, lead-free solder, bottom side of boards. | TTRR-B TTRR-D | • |  |
| | TT481 | White | Gloss | -40°F to 572°F -40°C to 300°C | Low profile film (1 mil) ideal for high temperatures, lead-free solder, top and bottom side of boards. | TTRR-B TTRR-D | • |  |
| | TT482 | White | Matte | -40°F to 572°F -40°C to 300°C | Low profile film (1 mil) ideal for high temperatures, lead-free solder, top and bottom side of boards. | TTRR-B TTRR-D | • |  |
| POLYESTER | TT700 | White | Gloss | -40°F to 302°F -40°C to 150°C | Product identification and top side labeling. | TTRR-B TTRR-D | • |   |
| | TT701 | White | Matte | -40°F to 302°F -40°C to 150°C | Product identification and top side labeling. | TTRR-B TTRR-D | • |   |
| | TT724 | Silver | Gloss | -40°F to 302°F -40°C to 150°C | Product and top side labeling. Extra heavy adhesive that adheres better to textured/rough surfaces. | TTRR-B TTRR-D | • |   |
| | TT730 | Silver | Gloss | -40°F to 302°F -40°C to 150°C | Material provides a "metal nameplate" look when labeling a product with UL / CSA nameplate or rating plate. | TTRR-B TTRR-D | • |  |
| | TT740 | Silver | Matte | 40°F to 302°F -40°C to 150°C | Material provides a "metal nameplate" look when labeling a product with UL / CSA nameplate or rating plate. | TTRR-B TTRR-D | • |   |
| | TT760 | White | Gloss | -40°F to 302°F -40°C to 150°C | Extra heavy adhesive that is ideal for textured / rough surfaces and and LSE plastics. Product and top side labeling. | TTRR-B TTRR-D | • |   |
| | TT770 | White | Gloss | -40°F to 275°F -40°C to 125°C | ESD / Static dissipative. Ideal for use in static free environments and top side labeling. | TTRR-D | | |
| VINYL | TT727 | Clear | Gloss | -20°F to 140°F -29°C to 60°C | Highly conformable film that is used on self-laminating wire and cable identification labels. | TTRR-A | |  |
| | TT733 | White | Matte | 40°F to 300°F -40°C to 150°C | Security material that has excellent conformability and is very fragile; tamper evident film. | TTRR-B TTRR-D | |  |
| POLYPROPYLENE | TT705A | White | Gloss | -40°F to 250°F -40°C to 121°C | Ideal material for use when the service temperature does not exceed 250°F. Lower cost alternative to polyester | TTRR-B TTRR-D | |  |
| | TT773 | White | Matte | -40°F to 176°F -40°C to 80°C | Product identification and barcoding when the heat resistance of polyester is not required. Adhesive offers high initial tack and excellent long-term adhesion. | TTRR-B TTRR-D | |  |
| PAPER | TT726 | White | Dull | -65°F to 180°F -54°C to 82°C | Removable paper label. | TTR | • | |
| | TT728 | White | Dull | -65°F to 180°F -54°C to 82°C | Packaging label. | TTR | • | |
| | TT516 | Clear | Semi-Gloss | -65°F to 180°F -54°C to 82°C | Packaging label - recommended for flexo printing. | TTR | • | |

DID YOU KNOW...

* UL recognition / CSA approval is contingent upon printing your IDENTCO labels with the appropriate IDENTCO TTRR™ series thermal transfer ribbon, which has been approved by the testing conducted at Underwriters Laboratories and/or the Canadian Standards Association.

LABEL REFERENCE GUIDE

STANDARD LABEL CONFIGURATION & TERMS

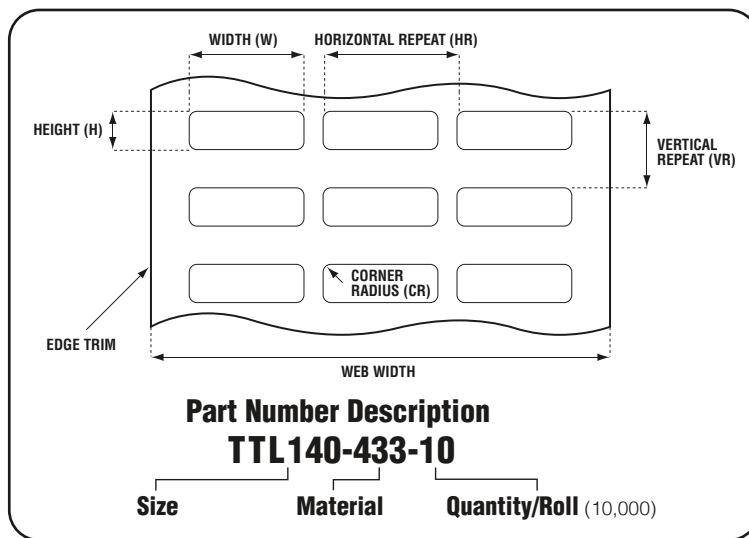

WIDTH (W)

- Horizontal measurement from left to right of label

HEIGHT (H)

- Vertical measurement from top to bottom of label

VERTICAL REPEAT (VR)

- Vertical measurement from the top of the label to the top of the next label

HORIZONTAL REPEAT (HR) (2 or more across)

- Horizontal measurement from the left edge of the label to the left edge of the next label
- Applies only to multiple across layouts

WEB

- Horizontal measurement of the liner

CORNER RADIUS (CR)

- Measurement of label corner — use corner measurement tool
- Standard = 0.0625" (1.59mm)
- 0.0156" (0.40mm) is the minimum to be used

EDGE TRIM

- Horizontal measurement from edge of liner to outer edge of closest label
- Measurement is taken from both ends of liner

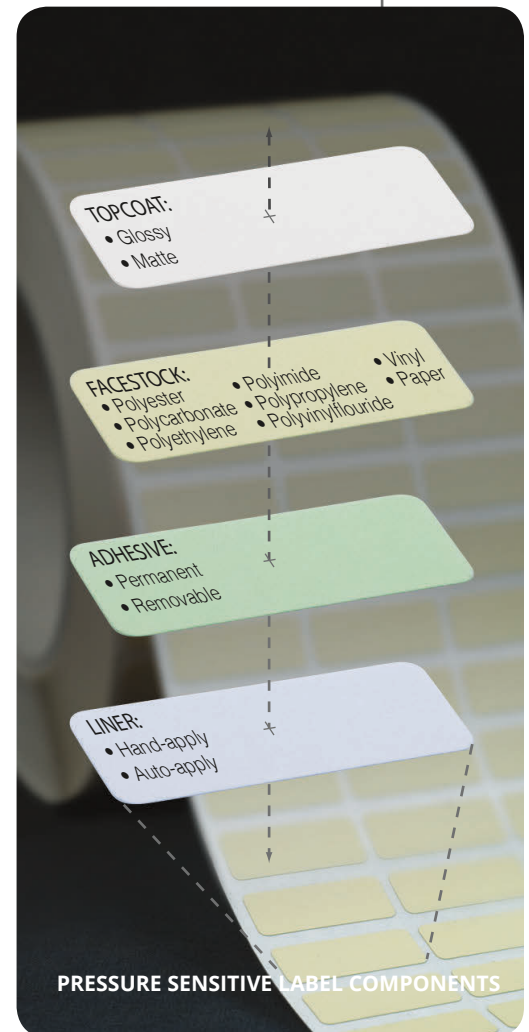

CIRCUIT BOARD & ELECTRONIC COMPONENT LABELS

TTL™ 100 SERIES

HIGHLIGHTS

- Endures harsh manufacturing environments
- Renders lifelong identification
- **UL/CSA approved***

FEATURES

- Thermal transfer printable
- Top-side, bottom-side, or after-process identification

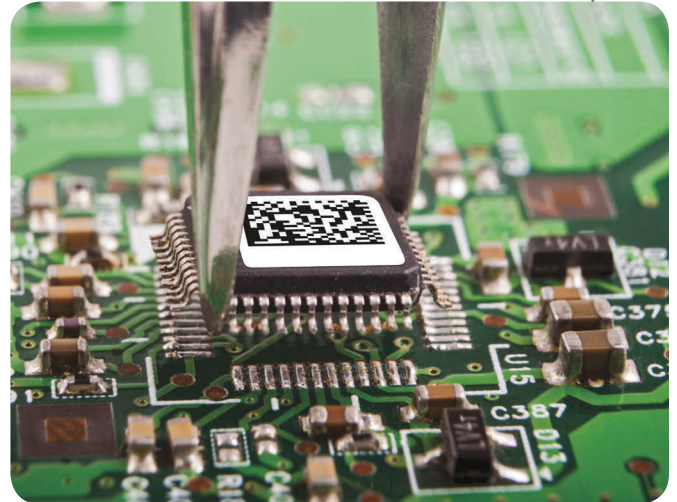

Engineered for use on printed circuit boards (PCBs) and electronic components, the TTL™ 100 series labels endure harsh environments such as high heat, aggressive fluxes, and caustic cleaners commonly used in the manufacturing process. Materials are intended for top-side, bottom-side, or after-process identification.

To achieve optimal print quality, durability, and **UL/CSA recognition**, IDENTCO TTL™ 100 series products have been thoroughly tested and qualified to match a TTRR™ series ribbon.

***UL/CSA recognitions are contingent upon printing with the appropriate IDENTCO material and TTRR™ ribbon combination specified by the Underwriters Laboratories and Canadian Standards Association.**

IN-STOCK MATERIALS INCLUDE:

- White polyester
- Silver polyester
- White polyimide
- Tan polyimide
- Low-profile polyimide
- Anti-static polyimide

Refer to pages 5-17 for charts and specifications



TTL™ 100 SERIES

| Actual Size | Part # | Inches (w x h) | mm (w x h) | Labels per row | Actual Size | Part # | Inches (w x h) | mm (w x h) | Labels per row |
|-------------|---|---|--|----------------|-------------|--------------------------------|------------------------------|--------------------------------|----------------|
| | TTL140-XXX - 10 | 0.17 x 0.13 | 4.32 x 3.30 | 5 | | TTL105-XXX-10 TTL131-XXX-10 | 1.00 x 3.75 1.00 x 3.75 | 25.40 x 9.53 25.40 x 9.53 | 3 1 |
| | TTL100-XXX - 10 TTL124-XXX - 10 TTL148-XXX - 10 | 0.25 x 0.25 0.25 x 0.25 0.25 x 0.25 | 6.35 x 6.35 6.35 x 6.35 6.35 x 6.35 | 12 8 7 | | TTL106-XXX-10 TTL147-XXX-10 | 1.00 x 0.50 1.00 x 0.50 | 25.40 x 12.70 25.40 x 12.70 | 3 1 |
| | TTL113-XXX - 10 | 0.27 x 0.27 | 6.86 x 6.86 | 5 | | TTL144-XXX-10 | 1.00 x 1.00 | 25.40 x 25.40 | 3 |
| | TTL139-XXX - 10 | 0.30 x 0.20 | 7.62 x 5.08 | 5 | | TTL138-XXX-10 | 1.1 x 0.38 | 27.94 x 9.65 | 2 |
| | TTL111-XXX - 10 | 0.3125 x 0.3125 | 7.93 x 7.93 | 5 | | TTL118-XXX-10 TTL134-XXX-10 | 1.25 x 0.25 1.25 x 0.25 | 31.75 x 6.35 31.75 x 6.35 | 2 1 |
| | TTL146-XXX - 10 | 0.315 x 0.315 | 8.00 x 8.00 | 8 | | TTL149-XXX-10 | 1.25 x 0.375 | 31.75 x 9.53 | 2 |
| | TTL116-XXX - 10 TTL125-XXX - 10 | 0.375 x 0.375 0.375 x 0.375 | 9.52 x 9.52 9.53 x 9.53 | 7 4 | | TTL115-XXX-10 TTL133-XXX-10 | 1.50 x 0.125 1.50 x 0.125 | 38.10 x 3.18 38.10 x 3.18 | 2 1 |
| | TTL145-XXX - 25 | 0.449 x 0.157 | 11.405 x 3.98 | 6 | | TTL114-XXX-10 TTL132-XXX-10 | 1.50 x 0.25 1.50 x 0.25 | 38.10 x 6.35 38.10 x 6.35 | 2 1 |
| | TTL121-XXX-10 TTL126-XXX-10 | 0.50 x 0.20 0.50 x 0.20 | 12.70 x 5.08 12.70 x 5.08 | 5 4 | | TTL119-XXX-10 | 1.5 x 0.5 | 38.10 x 12.70 | 2 |
| | TTL101-XXX-10 | 0.50 x 0.25 | 12.70 x 6.35 | 5 | | TTL107-XXX-10 | 1.75 x 0.25 | 44.45 x 6.35 | 1 |
| | TTL112-XXX-10 TTL127-XXX-10 | 0.50 x 0.4375 0.50 x 0.4375 | 12.70 x 11.125 12.70 x 11.125 | 5 3 | | TTL117-XXX-10 | 2.0 x 0.25 | 50.80 x 6.35 | 1 |
| | TTL137-XXX-10 | 0.60 x 0.25 | 15.24 x 6.35 | 1 | | TTL109-XXX-10 | 2.0 x 0.375 | 50.80 x 9.53 | 1 |
| | TTL102-XXX-10 TTL128-XXX-10 TTL136-XXX-10 | 0.65 x 0.20 0.65 x 0.20 0.65 x 0.20 | 16.51 x 5.08 16.51 x 5.08 16.51 x 5.08 | 4 2 1 | | TTL120-XXX-10 | 2.0 x 0.5 | 50.80 x 12.70 | 1 |
| | TTL122-XXX-10 | 0.70 x 0.375 | 17.78 x 9.53 | 4 | | TTL110-XXX-10 | 3.0 x 0.3125 | 76.20 x 7.93 | 1 |
| | TTL103-XXX-10 TTL129-XXX-10 TTL141-XXX-10 | 0.75 x 0.25 0.75 x 0.25 0.75 x 0.25 | 19.05 x 6.35 19.05 x 6.35 19.05 x 6.35 | 4 1 4 | | | | | |
| | TTL123-XXX-10 | 0.75 x 0.75 | 19.05 x 19.05 | 4 | | | | | |
| | TTL104-XXX-10 TTL130-XXX-10 | 0.90 x 0.25 0.90 x 0.25 | 22.86 x 6.35 22.86 x 6.35 | 3 1 | | | | | |
| | TTL135-XXX-10 | 1.00 x 0.25 | 25.40 x 6.35 | 1 | | | | | |

0.250" x 0.250"
6.35 mm x 6.35 mm

TTL™ 100

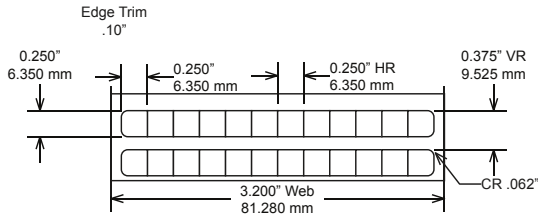

| Part Number | Material Description | TTRR™ |
|------------------|--------------------------------------|-------|
| TTL-100-433-10 | Hi-Performance Gloss White Polyimide | CR |
| TTL-100-403-10 | Gloss White Polyimide | B,D |
| TTL-100-403GR-10 | Gloss Green Polyimide | B,D |
| TTL-100-416-10 | Economy Gloss White Polyimide | B,D |
| TTL-100-451-10 | ESD Semi-Gloss White Polyimide | B,D |
| TTL-100-481-10 | Low Profile Gloss White Polyimide | B,CR |
| TTL-100-700-10 | Gloss White Polyester | B,D |

0.500" x 0.250"
12.70 mm x 12.70 mm

TTL™ 101

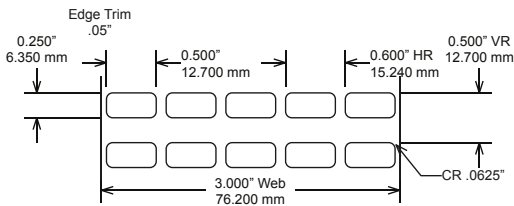

| Part Number | Material Description | TTRR™ |
|------------------|--------------------------------------|-------|
| TTL-101-433-10 | Hi-Performance Gloss White Polyimide | CR |
| TTL-101-403-10 | Gloss White Polyimide | B,D |
| TTL-101-403GR-10 | Gloss Green Polyimide | B,D |
| TTL-101-416-10 | Economy Gloss White Polyimide | B,D |
| TTL-101-451-10 | ESD Semi-Gloss White Polyimide | B,D |
| TTL-101-481-10 | Low Profile Gloss White Polyimide | B,CR |
| TTL-101-700-10 | Gloss White Polyester | B,D |

0.650" x 0.200"
16.51 mm x 5.08 mm

TTL™ 102

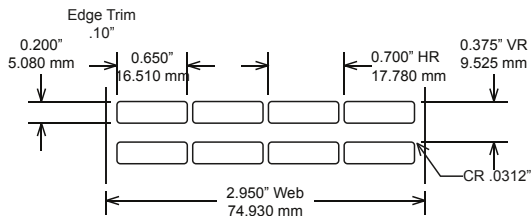

| Part Number | Material Description | TTRR™ |
|------------------|--------------------------------------|-------|
| TTL-102-433-10 | Hi-Performance Gloss White Polyimide | CR |
| TTL-102-403-10 | Gloss White Polyimide | B,D |
| TTL-102-403GR-10 | Gloss Green Polyimide | B,D |
| TTL-102-416-10 | Economy Gloss White Polyimide | B,D |
| TTL-102-451-10 | ESD Semi-Gloss White Polyimide | B,D |
| TTL-102-481-10 | Low Profile Gloss White Polyimide | B,CR |
| TTL-102-700-10 | Gloss White Polyester | B,D |

0.750" x 0.250"
19.05 mm x 6.35 mm

TTL™ 103

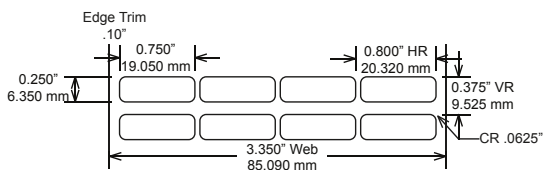

| Part Number | Material Description | TTRR™ |
|------------------|--------------------------------------|-------|
| TTL-103-433-10 | Hi-Performance Gloss White Polyimide | CR |
| TTL-103-403-10 | Gloss White Polyimide | B,D |
| TTL-103-403GR-10 | Gloss Green Polyimide | B,D |
| TTL-103-416-10 | Economy Gloss White Polyimide | B,D |
| TTL-103-451-10 | ESD Semi-Gloss White Polyimide | B,D |
| TTL-103-481-10 | Low Profile Gloss White Polyimide | B,CR |
| TTL-103-700-10 | Gloss White Polyester | B,D |

0.900" x 0.250"
22.86 mm x 6.35 mm

TTL™ 104

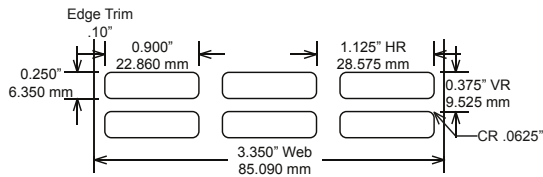

| Part Number | Material Description | TTRR™ |
|------------------|--------------------------------------|-------|
| TTL-104-433-10 | Hi-Performance Gloss White Polyimide | CR |
| TTL-104-403-10 | Gloss White Polyimide | B,D |
| TTL-104-403GR-10 | Gloss Green Polyimide | B,D |
| TTL-104-416-10 | Economy Gloss White Polyimide | B,D |
| TTL-104-451-10 | ESD Semi-Gloss White Polyimide | B,D |
| TTL-104-481-10 | Low Profile Gloss White Polyimide | B,CR |
| TTL-104-700-10 | Gloss White Polyester | B,D |

1.000" x 0.375"
25.40 mm x 9.53 mm

TTL™ 105

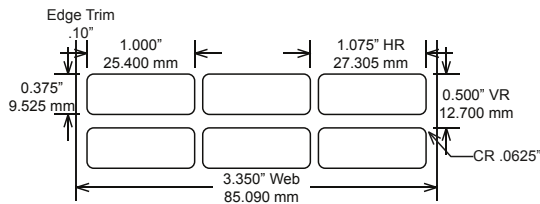

| Part Number | Material Description | TTRR™ |
|------------------|--------------------------------------|-------|
| TTL-105-433-10 | Hi-Performance Gloss White Polyimide | CR |
| TTL-105-403-10 | Gloss White Polyimide | B,D |
| TTL-105-403GR-10 | Gloss Green Polyimide | B,D |
| TTL-105-416-10 | Economy Gloss White Polyimide | B,D |
| TTL-105-451-10 | ESD Semi-Gloss White Polyimide | B,D |
| TTL-105-481-10 | Low Profile Gloss White Polyimide | B,CR |
| TTL-105-700-10 | Gloss White Polyester | B,D |

1.000" x 0.500"
25.40 mm x 12.70 mm

TTL™ 106

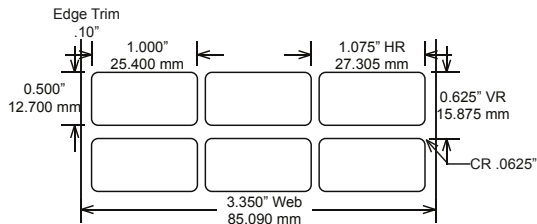

| Part Number | Material Description | TTRR™ |
|------------------|--------------------------------------|-------|
| TTL-106-433-10 | Hi-Performance Gloss White Polyimide | CR |
| TTL-106-403-10 | Gloss White Polyimide | B,D |
| TTL-106-403GR-10 | Gloss Green Polyimide | B,D |
| TTL-106-416-10 | Economy Gloss White Polyimide | B,D |
| TTL-106-451-10 | ESD Semi-Gloss White Polyimide | B,D |
| TTL-106-481-10 | Low Profile Gloss White Polyimide | B,CR |
| TTL-106-700-10 | Gloss White Polyester | B,D |

1.750" x 0.250"
44.45 mm x 6.35 mm

TTL™ 107

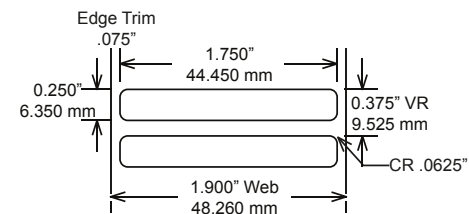

| Part Number | Material Description | TTRR™ |
|------------------|--------------------------------------|-------|
| TTL-107-433-10 | Hi-Performance Gloss White Polyimide | CR |
| TTL-107-403-10 | Gloss White Polyimide | B,D |
| TTL-107-403GR-10 | Gloss Green Polyimide | B,D |
| TTL-107-416-10 | Economy Gloss White Polyimide | B,D |
| TTL-107-451-10 | ESD Semi-Gloss White Polyimide | B,D |
| TTL-107-481-10 | Low Profile Gloss White Polyimide | B,CR |
| TTL-107-700-10 | Gloss White Polyester | B,D |

2.000" x 0.375"
50.80 mm x 9.35 mm

TTL™ 109

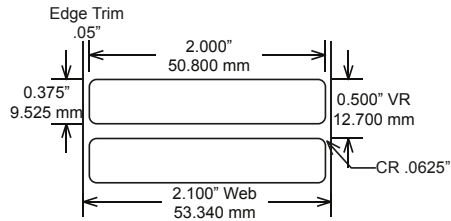

| Part Number | Material Description | TTRR™ |
|------------------|--------------------------------------|-------|
| TTL-109-433-10 | Hi-Performance Gloss White Polyimide | CR |
| TTL-109-403-10 | Gloss White Polyimide | B,D |
| TTL-109-403GR-10 | Gloss Green Polyimide | B,D |
| TTL-109-416-10 | Economy Gloss White Polyimide | B,D |
| TTL-109-451-10 | ESD Semi-Gloss White Polyimide | B,D |
| TTL-109-481-10 | Low Profile Gloss White Polyimide | B,CR |
| TTL-109-700-10 | Gloss White Polyester | B,D |

3.000" x 0.313"
76.20 mm x 7.95 mm

TTL™ 110

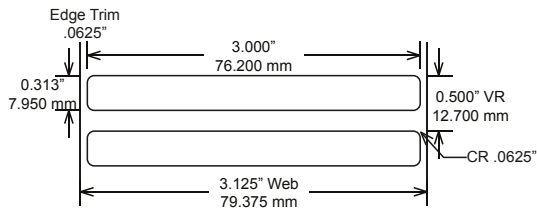

| Part Number | Material Description | TTRR™ |
|------------------|--------------------------------------|-------|
| TTL-110-433-10 | Hi-Performance Gloss White Polyimide | CR |
| TTL-110-403-10 | Gloss White Polyimide | B,D |
| TTL-110-403GR-10 | Gloss Green Polyimide | B,D |
| TTL-110-416-10 | Economy Gloss White Polyimide | B,D |
| TTL-110-451-10 | ESD Semi-Gloss White Polyimide | B,D |
| TTL-110-481-10 | Low Profile Gloss White Polyimide | B,CR |
| TTL-1010-700-10 | Gloss White Polyester | B,D |

0.313" x 0.313"
7.95 mm x 7.95 mm

TTL™ 111

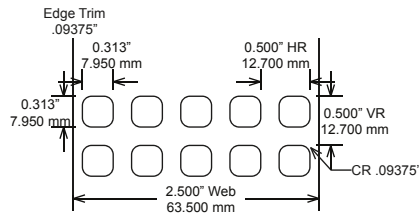

| Part Number | Material Description | TTRR™ |
|------------------|--------------------------------------|-------|
| TTL-111-433-10 | Hi-Performance Gloss White Polyimide | CR |
| TTL-111-403-10 | Gloss White Polyimide | B,D |
| TTL-111-403GR-10 | Gloss Green Polyimide | B,D |
| TTL-111-416-10 | Economy Gloss White Polyimide | B,D |
| TTL-111-451-10 | ESD Semi-Gloss White Polyimide | B,D |
| TTL-111-481-10 | Low Profile Gloss White Polyimide | B,CR |
| TTL-111-700-10 | Gloss White Polyester | B,D |

0.500" x 0.438"
12.70 mm x 11.13 mm

TTL™ 112

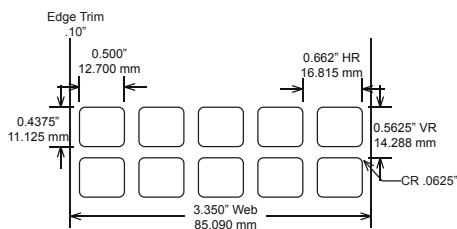

| Part Number | Material Description | TTRR™ |
|------------------|--------------------------------------|-------|
| TTL-112-433-10 | Hi-Performance Gloss White Polyimide | CR |
| TTL-112-403-10 | Gloss White Polyimide | B,D |
| TTL-112-403GR-10 | Gloss Green Polyimide | B,D |
| TTL-112-416-10 | Economy Gloss White Polyimide | B,D |
| TTL-112-451-10 | ESD Semi-Gloss White Polyimide | B,D |
| TTL-112-481-10 | Low Profile Gloss White Polyimide | B,CR |
| TTL-112-700-10 | Gloss White Polyester | B,D |

0.270" x 0.270"
6.86 mm x 6.86 mm

TTL™ 113

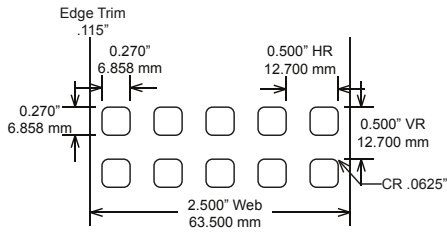

| Part Number | Material Description | TTRR™ |
|------------------|--------------------------------------|-------|
| TTL-113-433-10 | Hi-Performance Gloss White Polyimide | CR |
| TTL-113-403-10 | Gloss White Polyimide | B,D |
| TTL-113-403GR-10 | Gloss Green Polyimide | B,D |
| TTL-113-416-10 | Economy Gloss White Polyimide | B,D |
| TTL-113-451-10 | ESD Semi-Gloss White Polyimide | B,D |
| TTL-113-481-10 | Low Profile Gloss White Polyimide | B,CR |
| TTL-113-700-10 | Gloss White Polyester | B,D |

1.500" x 0.250"
38.10 mm x 6.35 mm

TTL™ 114

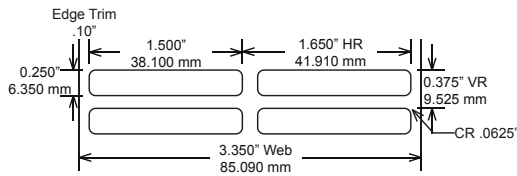

| Part Number | Material Description | TTRR™ |
|------------------|--------------------------------------|-------|
| TTL-114-433-10 | Hi-Performance Gloss White Polyimide | CR |
| TTL-114-403-10 | Gloss White Polyimide | B,D |
| TTL-114-403GR-10 | Gloss Green Polyimide | B,D |
| TTL-114-416-10 | Economy Gloss White Polyimide | B,D |
| TTL-114-451-10 | ESD Semi-Gloss White Polyimide | B,D |
| TTL-114-481-10 | Low Profile Gloss White Polyimide | B,CR |
| TTL-114-700-10 | Gloss White Polyester | B,D |

1.500" x 0.125"
38.10 mm x 3.18 mm

TTL™ 115

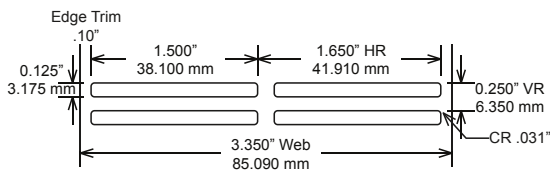

| Part Number | Material Description | TTRR™ |
|------------------|--------------------------------------|-------|
| TTL-115-433-10 | Hi-Performance Gloss White Polyimide | CR |
| TTL-115-403-10 | Gloss White Polyimide | B,D |
| TTL-115-403GR-10 | Gloss Green Polyimide | B,D |
| TTL-115-416-10 | Economy Gloss White Polyimide | B,D |
| TTL-115-451-10 | ESD Semi-Gloss White Polyimide | B,D |
| TTL-115-481-10 | Low Profile Gloss White Polyimide | B,CR |
| TTL-115-700-10 | Gloss White Polyester | B,D |

0.375" x 0.375"
9.52 mm x 9.52 mm

TTL™ 116

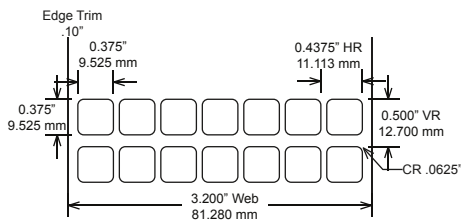

| Part Number | Material Description | TTRR™ |
|------------------|--------------------------------------|-------|
| TTL-116-433-10 | Hi-Performance Gloss White Polyimide | CR |
| TTL-116-403-10 | Gloss White Polyimide | B,D |
| TTL-116-403GR-10 | Gloss Green Polyimide | B,D |
| TTL-116-416-10 | Economy Gloss White Polyimide | B,D |
| TTL-116-451-10 | ESD Semi-Gloss White Polyimide | B,D |
| TTL-116-481-10 | Low Profile Gloss White Polyimide | B,CR |
| TTL-116-700-10 | Gloss White Polyester | B,D |

2.000" x 0.250"
50.80 mm x 6.35 mm

TTL™ 117

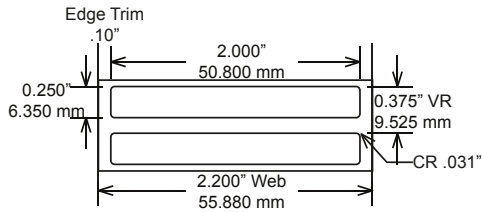

| Part Number | Material Description | TTRR™ |
|------------------|--------------------------------------|-------|
| TTL-117-433-10 | Hi-Performance Gloss White Polyimide | CR |
| TTL-117-403-10 | Gloss White Polyimide | B,D |
| TTL-117-403GR-10 | Gloss Green Polyimide | B,D |
| TTL-117-416-10 | Economy Gloss White Polyimide | B,D |
| TTL-117-451-10 | ESD Semi-Gloss White Polyimide | B,D |
| TTL-117-481-10 | Low Profile Gloss White Polyimide | B,CR |
| TTL-117-700-10 | Gloss White Polyester | B,D |

1.250" x 0.250"
31.75 mm x 6.35 mm

TTL™ 118

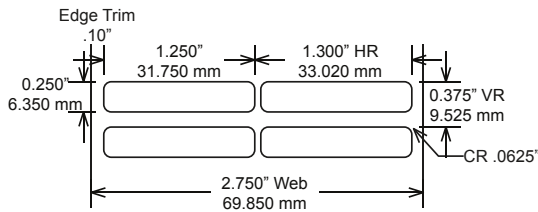

| Part Number | Material Description | TTRR™ |
|------------------|--------------------------------------|-------|
| TTL-118-433-10 | Hi-Performance Gloss White Polyimide | CR |
| TTL-118-403-10 | Gloss White Polyimide | B,D |
| TTL-118-403GR-10 | Gloss Green Polyimide | B,D |
| TTL-118-416-10 | Economy Gloss White Polyimide | B,D |
| TTL-118-451-10 | ESD Semi-Gloss White Polyimide | B,D |
| TTL-118-481-10 | Low Profile Gloss White Polyimide | B,CR |
| TTL-118-700-10 | Gloss White Polyester | B,D |

1.500" x 0.500"
38.10 mm x 12.70 mm

TTL™ 119

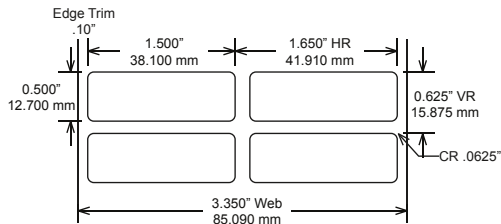

| Part Number | Material Description | TTRR™ |
|------------------|--------------------------------------|-------|
| TTL-119-433-10 | Hi-Performance Gloss White Polyimide | CR |
| TTL-119-403-10 | Gloss White Polyimide | B,D |
| TTL-119-403GR-10 | Gloss Green Polyimide | B,D |
| TTL-119-416-10 | Economy Gloss White Polyimide | B,D |
| TTL-119-451-10 | ESD Semi-Gloss White Polyimide | B,D |
| TTL-119-481-10 | Low Profile Gloss White Polyimide | B,CR |
| TTL-119-700-10 | Gloss White Polyester | B,D |

2.000" x 0.500"
50.80 mm x 12.70 mm

TTL™ 120

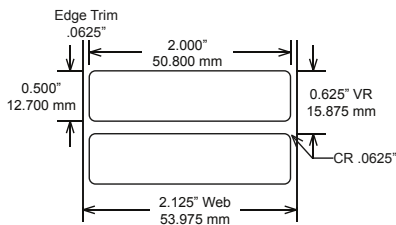

| Part Number | Material Description | TTRR™ |
|------------------|--------------------------------------|-------|
| TTL-120-433-10 | Hi-Performance Gloss White Polyimide | CR |
| TTL-120-403-10 | Gloss White Polyimide | B,D |
| TTL-120-403GR-10 | Gloss Green Polyimide | B,D |
| TTL-120-416-10 | Economy Gloss White Polyimide | B,D |
| TTL-120-451-10 | ESD Semi-Gloss White Polyimide | B,D |
| TTL-120-481-10 | Low Profile Gloss White Polyimide | B,CR |
| TTL-120-700-10 | Gloss White Polyester | B,D |

0.500" x 0.200"
12.70 mm x 5.08 mm

TTL™ 121

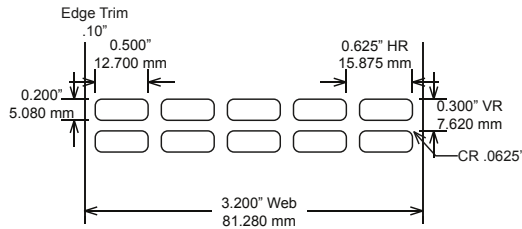

| Part Number | Material Description | TTRR™ |
|------------------|--------------------------------------|-------|
| TTL-121-433-10 | Hi-Performance Gloss White Polyimide | CR |
| TTL-121-403-10 | Gloss White Polyimide | B,D |
| TTL-121-403GR-10 | Gloss Green Polyimide | B,D |
| TTL-121-416-10 | Economy Gloss White Polyimide | B,D |
| TTL-121-451-10 | ESD Semi-Gloss White Polyimide | B,D |
| TTL-121-481-10 | Low Profile Gloss White Polyimide | B,CR |
| TTL-121-700-10 | Gloss White Polyester | B,D |

0.700" x 0.375"
17.78 mm x 9.53 mm

TTL™ 122

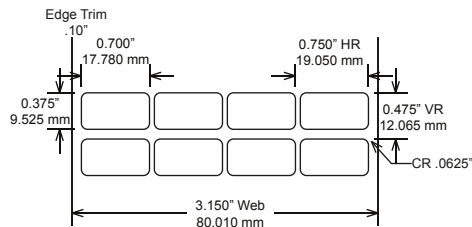

| Part Number | Material Description | TTRR™ |
|------------------|--------------------------------------|-------|
| TTL-122-433-10 | Hi-Performance Gloss White Polyimide | CR |
| TTL-122-403-10 | Gloss White Polyimide | B,D |
| TTL-122-403GR-10 | Gloss Green Polyimide | B,D |
| TTL-122-416-10 | Economy Gloss White Polyimide | B,D |
| TTL-122-451-10 | ESD Semi-Gloss White Polyimide | B,D |
| TTL-122-481-10 | Low Profile Gloss White Polyimide | B,CR |
| TTL-122-700-10 | Gloss White Polyester | B,D |

0.750" x 0.750"
19.05 mm x 19.05 mm

TTL™ 123

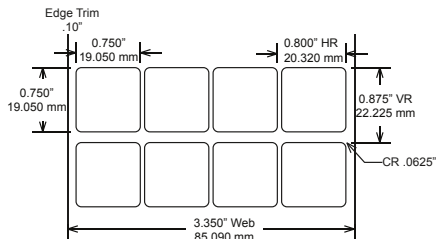

| Part Number | Material Description | TTRR™ |
|------------------|--------------------------------------|-------|
| TTL-123-433-10 | Hi-Performance Gloss White Polyimide | CR |
| TTL-123-403-10 | Gloss White Polyimide | B,D |
| TTL-123-403GR-10 | Gloss Green Polyimide | B,D |
| TTL-123-416-10 | Economy Gloss White Polyimide | B,D |
| TTL-123-451-10 | ESD Semi-Gloss White Polyimide | B,D |
| TTL-123-481-10 | Low Profile Gloss White Polyimide | B,CR |
| TTL-123-700-10 | Gloss White Polyester | B,D |

0.250" x 0.250"
6.35 mm x 6.35 mm

TTL™ 124

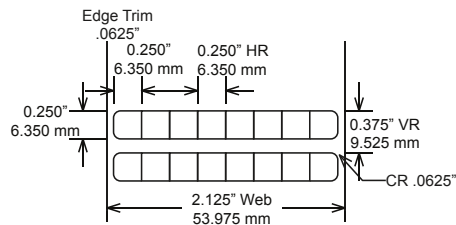

| Part Number | Material Description | TTRR™ |
|------------------|--------------------------------------|-------|
| TTL-124-433-10 | Hi-Performance Gloss White Polyimide | CR |
| TTL-124-403-10 | Gloss White Polyimide | B,D |
| TTL-124-403GR-10 | Gloss Green Polyimide | B,D |
| TTL-124-416-10 | Economy Gloss White Polyimide | B,D |
| TTL-124-451-10 | ESD Semi-Gloss White Polyimide | B,D |
| TTL-124-481-10 | Low Profile Gloss White Polyimide | B,CR |
| TTL-124-700-10 | Gloss White Polyester | B,D |

0.375" x 0.375"
9.53 mm x 9.53 mm

TTL™ 125

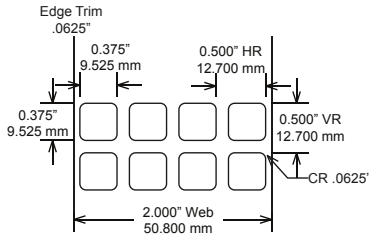

| Part Number | Material Description | TTRR™ |
|------------------|--------------------------------------|-------|
| TTL-125-433-10 | Hi-Performance Gloss White Polyimide | CR |
| TTL-125-403-10 | Gloss White Polyimide | B,D |
| TTL-125-403GR-10 | Gloss Green Polyimide | B,D |
| TTL-125-416-10 | Economy Gloss White Polyimide | B,D |
| TTL-125-451-10 | ESD Semi-Gloss White Polyimide | B,D |
| TTL-125-481-10 | Low Profile Gloss White Polyimide | B,CR |
| TTL-125-700-10 | Gloss White Polyester | B,D |

0.500" x 0.200"
12.70 mm x 5.08 mm

TTL™ 126

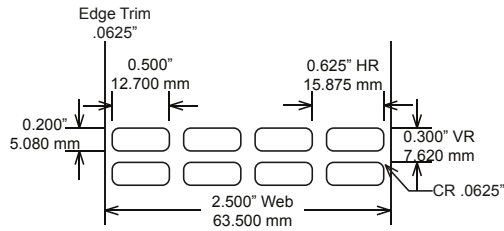

| Part Number | Material Description | TTRR™ |
|------------------|--------------------------------------|-------|
| TTL-126-433-10 | Hi-Performance Gloss White Polyimide | CR |
| TTL-126-403-10 | Gloss White Polyimide | B,D |
| TTL-126-403GR-10 | Gloss Green Polyimide | B,D |
| TTL-126-416-10 | Economy Gloss White Polyimide | B,D |
| TTL-126-451-10 | ESD Semi-Gloss White Polyimide | B,D |
| TTL-126-481-10 | Low Profile Gloss White Polyimide | B,CR |
| TTL-126-700-10 | Gloss White Polyester | B,D |

0.500" x 0.438"
12.70 mm x 11.13 mm

TTL™ 127

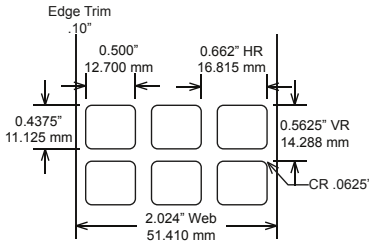

| Part Number | Material Description | TTRR™ |
|------------------|--------------------------------------|-------|
| TTL-127-433-10 | Hi-Performance Gloss White Polyimide | CR |
| TTL-127-403-10 | Gloss White Polyimide | B,D |
| TTL-127-403GR-10 | Gloss Green Polyimide | B,D |
| TTL-127-416-10 | Economy Gloss White Polyimide | B,D |
| TTL-127-451-10 | ESD Semi-Gloss White Polyimide | B,D |
| TTL-127-481-10 | Low Profile Gloss White Polyimide | B,CR |
| TTL-127-700-10 | Gloss White Polyester | B,D |

0.650" x 0.200"
16.51 mm x 5.08 mm

TTL™ 128

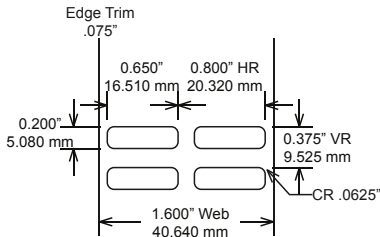

| Part Number | Material Description | TTRR™ |
|------------------|--------------------------------------|-------|
| TTL-128-433-10 | Hi-Performance Gloss White Polyimide | CR |
| TTL-128-403-10 | Gloss White Polyimide | B,D |
| TTL-128-403GR-10 | Gloss Green Polyimide | B,D |
| TTL-128-416-10 | Economy Gloss White Polyimide | B,D |
| TTL-128-451-10 | ESD Semi-Gloss White Polyimide | B,D |
| TTL-128-481-10 | Low Profile Gloss White Polyimide | B,CR |
| TTL-128-700-10 | Gloss White Polyester | B,D |

0.750" x 0.250"
19.05 mm x 6.35 mm

TTL™ 129

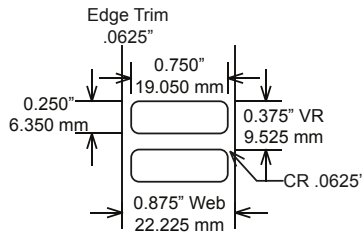

| Part Number | Material Description | TTRR™ |
|------------------|--------------------------------------|-------|
| TTL-129-433-10 | Hi-Performance Gloss White Polyimide | CR |
| TTL-129-403-10 | Gloss White Polyimide | B,D |
| TTL-129-403GR-10 | Gloss Green Polyimide | B,D |
| TTL-129-416-10 | Economy Gloss White Polyimide | B,D |
| TTL-129-451-10 | ESD Semi-Gloss White Polyimide | B,D |
| TTL-129-481-10 | Low Profile Gloss White Polyimide | B,CR |
| TTL-129-700-10 | Gloss White Polyester | B,D |

0.900" x 0.250"
22.86 mm x 6.35 mm

TTL™ 130

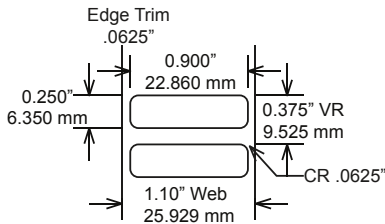

| Part Number | Material Description | TTRR™ |
|------------------|--------------------------------------|-------|
| TTL-130-433-10 | Hi-Performance Gloss White Polyimide | CR |
| TTL-130-403-10 | Gloss White Polyimide | B,D |
| TTL-130-403GR-10 | Gloss Green Polyimide | B,D |
| TTL-130-416-10 | Economy Gloss White Polyimide | B,D |
| TTL-130-451-10 | ESD Semi-Gloss White Polyimide | B,D |
| TTL-130-481-10 | Low Profile Gloss White Polyimide | B,CR |
| TTL-130-700-10 | Gloss White Polyester | B,D |

1.000" x 0.375"
25.40 mm x 9.53 mm

TTL™ 131

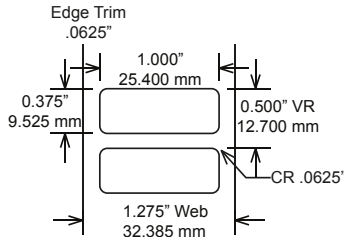

| Part Number | Material Description | TTRR™ |
|------------------|--------------------------------------|-------|
| TTL-131-433-10 | Hi-Performance Gloss White Polyimide | CR |
| TTL-131-403-10 | Gloss White Polyimide | B,D |
| TTL-131-403GR-10 | Gloss Green Polyimide | B,D |
| TTL-131-416-10 | Economy Gloss White Polyimide | B,D |
| TTL-131-451-10 | ESD Semi-Gloss White Polyimide | B,D |
| TTL-131-481-10 | Low Profile Gloss White Polyimide | B,CR |
| TTL-131-700-10 | Gloss White Polyester | B,D |

1.500" x 0.250"
38.10 mm x 6.35 mm

TTL™ 132

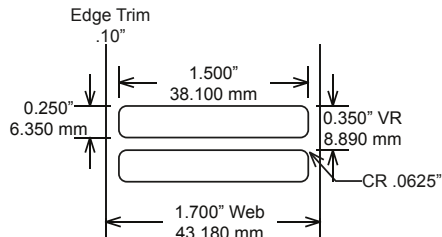

| Part Number | Material Description | TTRR™ |
|------------------|--------------------------------------|-------|
| TTL-132-433-10 | Hi-Performance Gloss White Polyimide | CR |
| TTL-132-403-10 | Gloss White Polyimide | B,D |
| TTL-132-403GR-10 | Gloss Green Polyimide | B,D |
| TTL-132-416-10 | Economy Gloss White Polyimide | B,D |
| TTL-132-451-10 | ESD Semi-Gloss White Polyimide | B,D |
| TTL-132-423-10 | Low Profile Gloss White Polyimide | B,CR |
| TTL-132-700-10 | Gloss White Polyester | B,D |

1.500" x 0.125"
38.10 mm x 3.18 mm

TTL™ 133

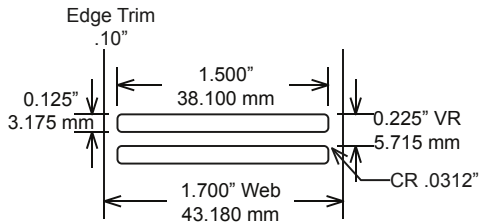

| Part Number | Material Description | TTRR™ |
|------------------|--------------------------------------|---------|
| TTL-133-433-10 | Hi-Performance Gloss White Polyimide | CR |
| TTL-133-403-10 | Gloss White Polyimide | B,D |
| TTL-133-403GR-10 | Gloss Green Polyimide | B,D |
| TTL-133-416-10 | Economy Gloss White Polyimide | B,D |
| TTL-133-451-10 | ESD Semi-Gloss White Polyimide | B,D |
| TTL-133-481-10 | Low Profile Gloss White Polyimide | B,CR |
| TTL-133-700-10 | Gloss White Polyester | B,D B,D |

1.250" x 0.250"
31.75 mm x 6.35 mm

TTL™ 134

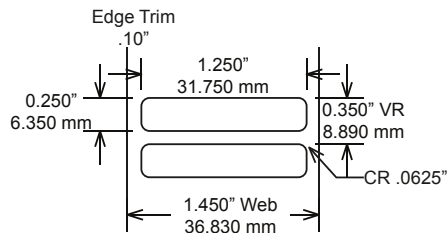

| Part Number | Material Description | TTRR™ |
|------------------|--------------------------------------|-------|
| TTL-134-433-10 | Hi-Performance Gloss White Polyimide | CR |
| TTL-134-403-10 | Gloss White Polyimide | B,D |
| TTL-134-403GR-10 | Gloss Green Polyimide | B,D |
| TTL-134-416-10 | Economy Gloss White Polyimide | B,D |
| TTL-134-451-10 | ESD Semi-Gloss White Polyimide | B,D |
| TTL-134-481-10 | Low Profile Gloss White Polyimide | B,CR |
| TTL-134-700-10 | Gloss White Polyester | B,D |

1.000" x 0.250"
25.40 mm x 6.35 mm

TTL™ 135

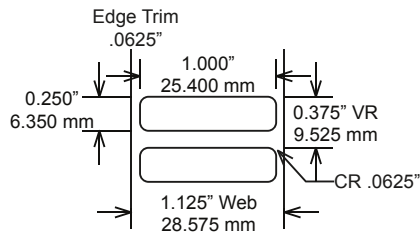

| Part Number | Material Description | TTRR™ |
|------------------|--------------------------------------|-------|
| TTL-135-433-10 | Hi-Performance Gloss White Polyimide | CR |
| TTL-135-403-10 | Gloss White Polyimide | B,D |
| TTL-135-403GR-10 | Gloss Green Polyimide | B,D |
| TTL-135-416-10 | Economy Gloss White Polyimide | B,D |
| TTL-135-451-10 | ESD Semi-Gloss White Polyimide | B,D |
| TTL-135-481-10 | Low Profile Gloss White Polyimide | B,CR |
| TTL-135-700-10 | Gloss White Polyester | B,D |

0.650" x 0.200"
16.51 mm x 5.08 mm

TTL™ 136

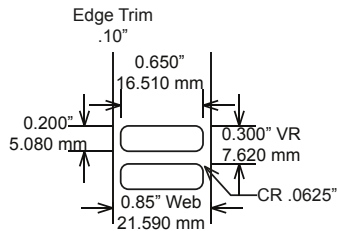

| Part Number | Material Description | TTRR™ |
|------------------|--------------------------------------|-------|
| TTL-136-433-10 | Hi-Performance Gloss White Polyimide | CR |
| TTL-136-403-10 | Gloss White Polyimide | B,D |
| TTL-136-403GR-10 | Gloss Green Polyimide | B,D |
| TTL-136-416-10 | Economy Gloss White Polyimide | B,D |
| TTL-136-451-10 | ESD Semi-Gloss White Polyimide | B,D |
| TTL-136-481-10 | Low Profile Gloss White Polyimide | B,CR |
| TTL-136-700-10 | Gloss White Polyester | B,36 |

0.600" x 0.250"
15.24 mm x 6.35 mm

TTL™ 137

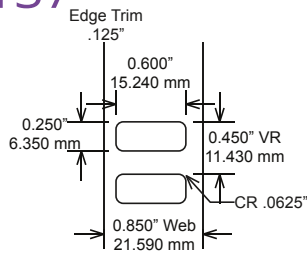

| Part Number | Material Description | TTRR™ |
|------------------|--------------------------------------|-------|
| TTL-137-433-10 | Hi-Performance Gloss White Polyimide | CR |
| TTL-137-403-10 | Gloss White Polyimide | B,D |
| TTL-137-403GR-10 | Gloss Green Polyimide | B,D |
| TTL-137-416-10 | Economy Gloss White Polyimide | B,D |
| TTL-137-451-10 | ESD Semi-Gloss White Polyimide | B,D |
| TTL-137-481-10 | Low Profile Gloss White Polyimide | B,CR |
| TTL-137-700-10 | Gloss White Polyester | B,D |

1.100" x 0.380"
27.94 mm x 9.65 mm

TTL™ 138

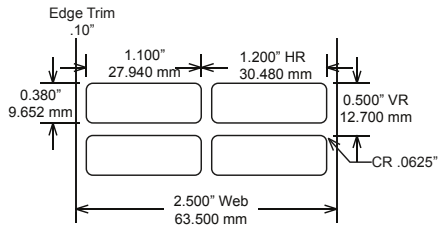

| Part Number | Material Description | TTRR™ |
|------------------|--------------------------------------|-------|
| TTL-138-433-10 | Hi-Performance Gloss White Polyimide | CR |
| TTL-138-403-10 | Gloss White Polyimide | B,D |
| TTL-138-403GR-10 | Gloss Green Polyimide | B,D |
| TTL-138-416-10 | Economy Gloss White Polyimide | B,D |
| TTL-138-451-10 | ESD Semi-Gloss White Polyimide | B,D |
| TTL-138-481-10 | Low Profile Gloss White Polyimide | B,CR |
| TTL-138-700-10 | Gloss White Polyester | B,D |

0.300" x 0.200"
7.62 mm x 5.08 mm

TTL™ 139

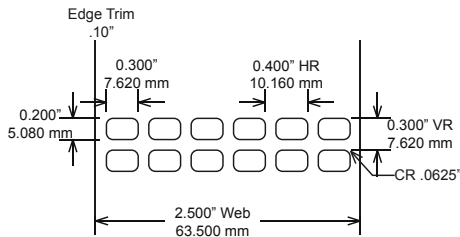

| Part Number | Material Description | TTRR™ |
|------------------|--------------------------------------|-------|
| TTL-139-433-10 | Hi-Performance Gloss White Polyimide | CR |
| TTL-139-403-10 | Gloss White Polyimide | B,D |
| TTL-139-403GR-10 | Gloss Green Polyimide | B,D |
| TTL-139-416-10 | Economy Gloss White Polyimide | B,D |
| TTL-139-451-10 | ESD Semi-Gloss White Polyimide | B,D |
| TTL-139-481-10 | Low Profile Gloss White Polyimide | B,CR |
| TTL-139-700-10 | Gloss White Polyester | B,D |

0.170" x 0.130"
4.32 mm x 3.30 mm

TTL™ 140

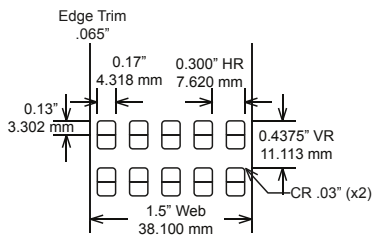

| Part Number | Material Description | TTRR™ |
|------------------|--------------------------------------|-------|
| TTL-140-433-10 | Hi-Performance Gloss White Polyimide | CR |
| TTL-140-403-10 | Gloss White Polyimide | B,D |
| TTL-140-403GR-10 | Gloss Green Polyimide | B,D |
| TTL-140-416-10 | Economy Gloss White Polyimide | B,D |
| TTL-140-451-10 | ESD Semi-Gloss White Polyimide | B,D |
| TTL-140-481-10 | Low Profile Gloss White Polyimide | B,CR |
| TTL-140-700-10 | Gloss White Polyester | B,D |

0.750" x 0.250"
19.05 mm x 6.35 mm

TTL™ 141

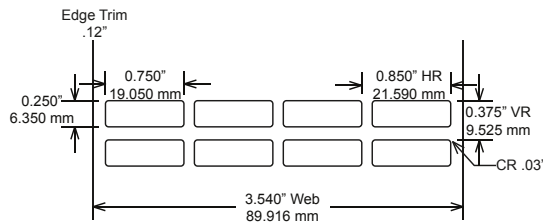

| Part Number | Material Description | TTRR™ |
|------------------|--------------------------------------|-------|
| TTL-141-433-10 | Hi-Performance Gloss White Polyimide | CR |
| TTL-141-403-10 | Gloss White Polyimide | B,D |
| TTL-141-403GR-10 | Gloss Green Polyimide | B,D |
| TTL-141-416-10 | Economy Gloss White Polyimide | B,D |
| TTL-141-451-10 | ESD Semi-Gloss White Polyimide | B,D |
| TTL-141-481-10 | Low Profile Gloss White Polyimide | B,CR |
| TTL-141-700-10 | Gloss White Polyester | B,D |

1.000" x 1.000"
25.40 mm x 25.40 mm

TTL™ 144

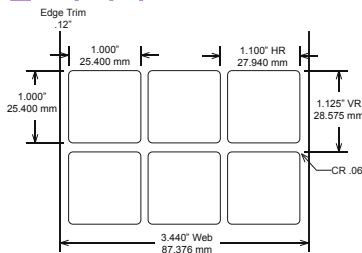

| Part Number | Material Description | TTRR™ |
|------------------|--------------------------------------|-------|
| TTL-144-433-10 | Hi-Performance Gloss White Polyimide | CR |
| TTL-144-403-10 | Gloss White Polyimide | B,D |
| TTL-144-403GR-10 | Gloss Green Polyimide | B,D |
| TTL-144-416-10 | Economy Gloss White Polyimide | B,D |
| TTL-144-451-10 | ESD Semi-Gloss White Polyimide | B,D |
| TTL-144-481-10 | Low Profile Gloss White Polyimide | B,CR |
| TTL-144-700-10 | Gloss White Polyester | B,D |

0.449" x 0.157"
11.41 mm x 3.98 mm

TTL™ 145

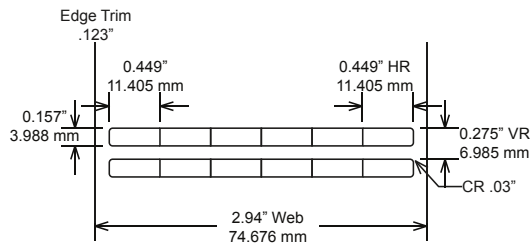

| Part Number | Material Description | TTRR™ |
|------------------|--------------------------------------|-------|
| TTL-145-433-10 | Hi-Performance Gloss White Polyimide | CR |
| TTL-145-403-10 | Gloss White Polyimide | B,D |
| TTL-145-403GR-10 | Gloss Green Polyimide | B,D |
| TTL-145-416-10 | Economy Gloss White Polyimide | B,D |
| TTL-145-451-10 | ESD Semi-Gloss White Polyimide | B,D |
| TTL-145-481-10 | Low Profile Gloss White Polyimide | B,CR |
| TTL-145-700-10 | Gloss White Polyester | B,D |

0.315" x 0.315"
8.00 mm x 8.00 mm

TTL™ 146

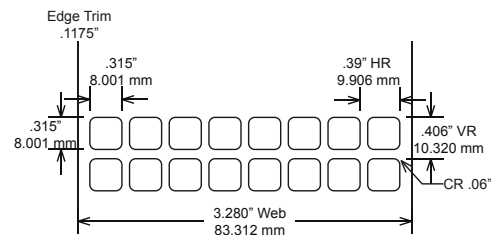

| Part Number | Material Description | TTRR™ |
|------------------|--------------------------------------|-------|
| TTL-146-433-10 | Hi-Performance Gloss White Polyimide | CR |
| TTL-146-403-10 | Gloss White Polyimide | B,D |
| TTL-146-403GR-10 | Gloss Green Polyimide | B,D |
| TTL-146-416-10 | Economy Gloss White Polyimide | B,D |
| TTL-146-451-10 | ESD Semi-Gloss White Polyimide | B,D |
| TTL-146-481-10 | Low Profile Gloss White Polyimide | B,CR |
| TTL-146-700-10 | Gloss White Polyester | B,D |

1.000" x 0.500"
25.40 mm x 12.70 mm

TTL™ 147

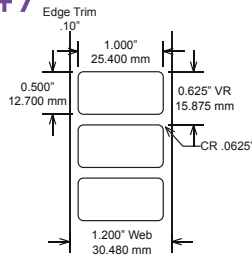

| Part Number | Material Description | TTRR™ |
|------------------|--------------------------------------|-------|
| TTL-147-433-10 | Hi-Performance Gloss White Polyimide | CR |
| TTL-147-403-10 | Gloss White Polyimide | B,D |
| TTL-147-403GR-10 | Gloss Green Polyimide | B,D |
| TTL-147-416-10 | Economy Gloss White Polyimide | B,D |
| TTL-147-451-10 | ESD Semi-Gloss White Polyimide | B,D |
| TTL-147-481-10 | Low Profile Gloss White Polyimide | B,CR |
| TTL-147-700-10 | Gloss White Polyester | B,D |

0.250" x 0.250"
6.35 mm x 6.35 mm

TTL™ 148

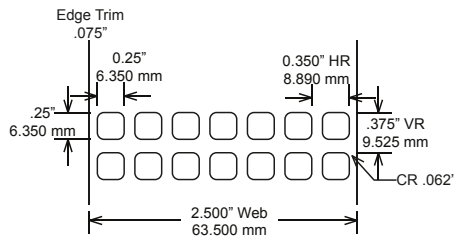

| Part Number | Material Description | TTRR™ |
|------------------|--------------------------------------|-------|
| TTL-148-433-10 | Hi-Performance Gloss White Polyimide | CR |
| TTL-148-403-10 | Gloss White Polyimide | B,D |
| TTL-148-403GR-10 | Gloss Green Polyimide | B,D |
| TTL-148-416-10 | Economy Gloss White Polyimide | B,D |
| TTL-148-451-10 | ESD Semi-Gloss White Polyimide | B,D |
| TTL-148-481-10 | Low Profile Gloss White Polyimide | B,CR |
| TTL-148-700-10 | Gloss White Polyester | B,D |

1.250" x 0.375"
31.75 mm x 9.53 mm

TTL™ 149

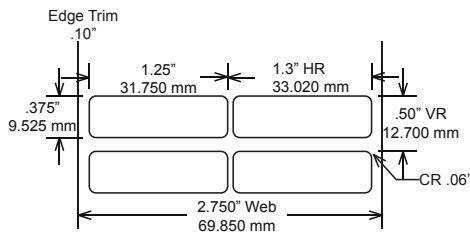

| Part Number | Material Description | TTRR™ |
|------------------|--------------------------------------|-------|
| TTL-149-433-10 | Hi-Performance Gloss White Polyimide | CR |
| TTL-149-403-10 | Gloss White Polyimide | B,D |
| TTL-149-403GR-10 | Gloss Green Polyimide | B,D |
| TTL-149-416-10 | Economy Gloss White Polyimide | B,D |
| TTL-149-451-10 | ESD Semi-Gloss White Polyimide | B,D |
| TTL-149-481-10 | Low Profile Gloss White Polyimide | B,CR |
| TTL-149-700-10 | Gloss White Polyester | B,D |

your #1 resource for...
**Thermal Transfer
 Ribbons**



Pages 30-31

WIRE & CABLE IDENTIFICATION LABELS

TTL™ 200 SERIES

HIGHLIGHTS

- Excellent product conformity
- Unique “site-hole” technology
- **UL approved***

FEATURES

- Thermal transfer printable
- Self-laminating vinyl film
- Custom sizes, colors, and formats

Designed for cable and wire identification, the TTL™ 200 Series also works on other surfaces requiring conformability. IDENTCO unique “site-hole” technology allows virtually any thermal transfer printer to print clear self-laminating labels accurately with minimal waste.

IDENTCO wire and cable labels have been thoroughly tested and qualified to match the TTRR™-A ribbon.

Combining the wire and cable labels with the TTRR™-A ribbon promises optimal print quality, **UL recognition** and lifelong product labels.

***UL recognition is contingent upon printing with the appropriate IDENTCO material and TTRR™ ribbon combination as specified by Underwriters Laboratories testing.**

Refer to pages 19–22 for charts and specifications



TTL™ 200 SERIES

1

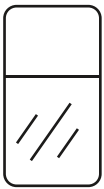

2

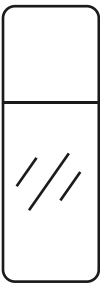

3

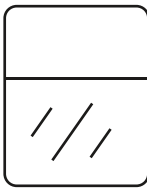

4

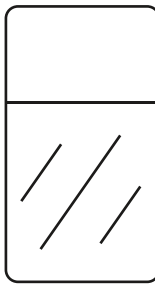

5

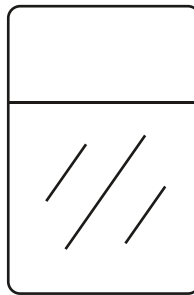

6

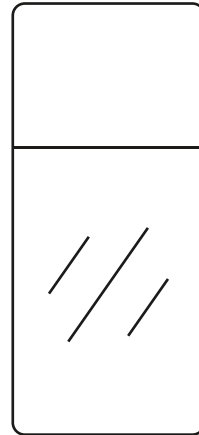

7

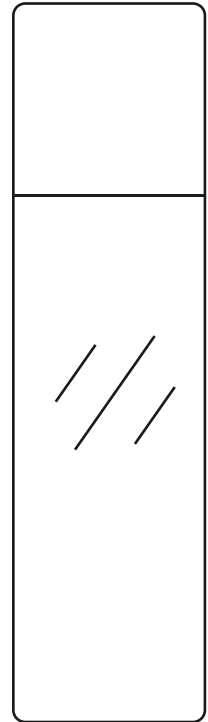

8

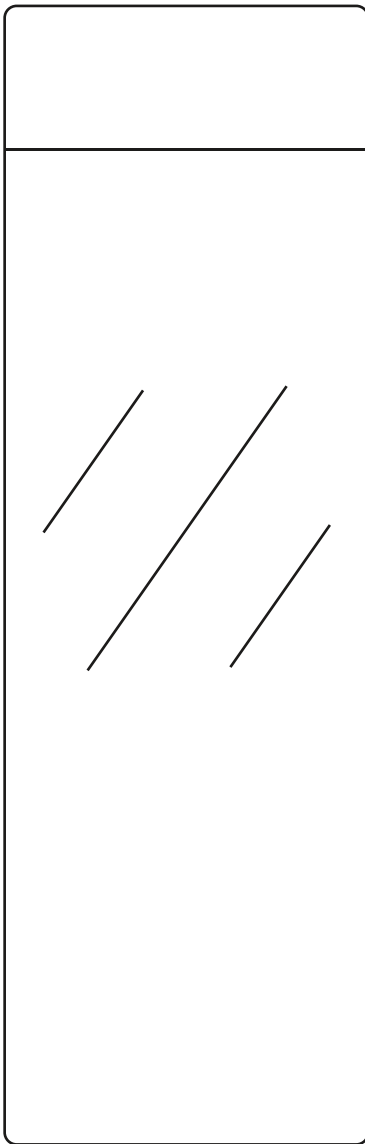

9

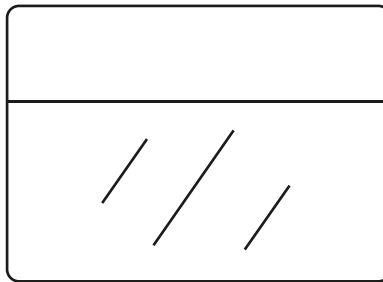

10

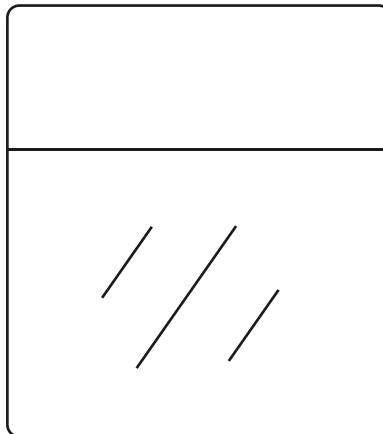

11

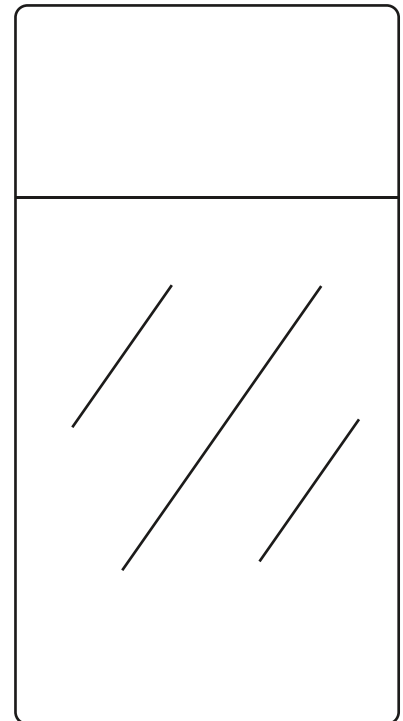

| Part # | Qty / roll (x1000) | Inches (w x h) | MM (w x h) | Labels/ row |
|-------------------|-----------------------|-------------------|----------------|----------------|
| 1) TTL209-XXX-10 | | 0.50 x 0.94 | 12.70 x 23.90 | 6 |
| 2) TTL200-XXX-10 | | 0.50 x 1.4375 | 12.70 x 36.50 | 5 |
| 3) TTL207-XXX-10 | | 0.75 x 0.9375 | 19.05 x 23.80 | 4 |
| 4) TTL201-XXX-4 | | 0.80 x 1.4375 | 20.32 x 36.50 | 4 |
| 5) TTL205-XXX-7.5 | | 1.00 x 1.50 | 25.40 x 38.10 | 3 |
| 6) TTL202-XXX-5 | | 1.00 x 2.25 | 25.40 x 57.20 | 3 |
| 7) TTL203-XXX-3.5 | | 1.00 x 3.75 | 25.40 x 95.30 | 3 |
| 8) TTL208-XXX-1 | | 1.90 x 5.94 | 48.26 x 151.00 | 2 |
| 9) TTL210-XXX-2.5 | | 2.00 x 1.4375 | 50.80 x 36.50 | 2 |
| 10) TTL204-XXX-1 | | 2.00 x 2.25 | 50.80 x 57.20 | 1 |
| 11) TTL206-XXX-1 | | 2.00 x 3.75 | 50.80 x 95.30 | 1 |

Labels shown actual size

0.500" x 1.438"
12.70 mm x 36.51 mm

Part Number **Material Description** **TTRR™**

TTL™ 200

TTL200-727-10 Self-Laminating Vinyl with White Thermal Transfer Printable Area A

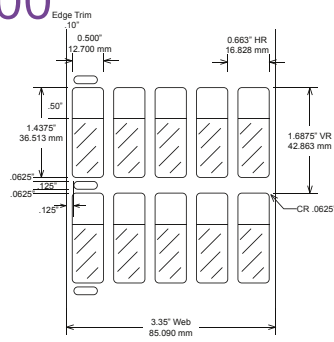

0.800" x 1.438"
20.32 mm x 36.51 mm

Part Number **Material Description** **TTRR™**

TTL™ 201

TTL201-727-4 Self-Laminating Vinyl with White Thermal Transfer Printable Area A

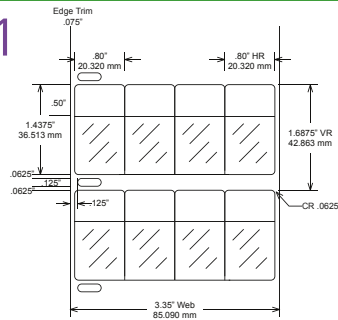

1.000" x 2.250"
25.40 mm x 57.15 mm

Part Number **Material Description** **TTRR™**

TTL™ 202

TTL202-727-5 Self-Laminating Vinyl with White Thermal Transfer Printable Area A

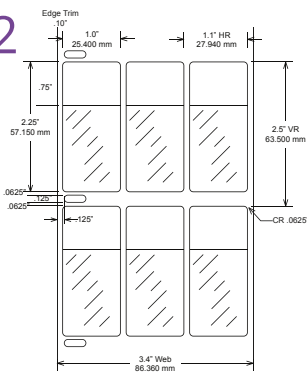

1.000" x 3.750"
25.40 mm x 95.25 mm

Part Number **Material Description** **TTRR™**

TTL™ 203

TTL203-727-3.5 Self-Laminating Vinyl with White Thermal Transfer Printable Area A

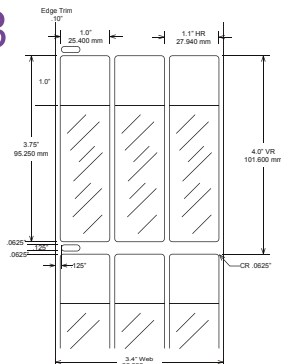

2.000" x 2.250"
50.80 mm x 57.15 mm

TTL™ 204

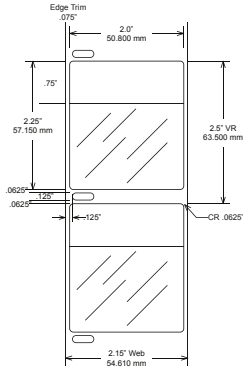

Part Number

TTL204-727-1

Material Description

Self-Laminating Vinyl with White Thermal Transfer Printable Area

TTRR™

A

1.000" x 1.500"
25.40 mm x 38.10 mm

TTL™ 205

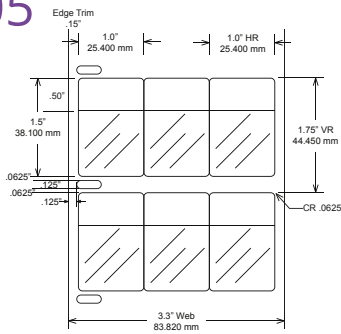

Part Number

TTL205-727-7.5

Material Description

Self-Laminating Vinyl with White Thermal Transfer Printable Area

TTRR™

A

2.000" x 3.750"
50.80 mm x 95.25 mm

TTL™ 206

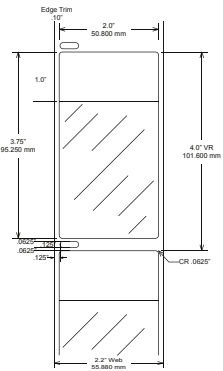

Part Number

TTL206-727-1

Material Description

Self-Laminating Vinyl with White Thermal Transfer Printable Area

TTRR™

A

0.750" x 0.938"
19.05 mm x 23.81 mm

TTL™ 207

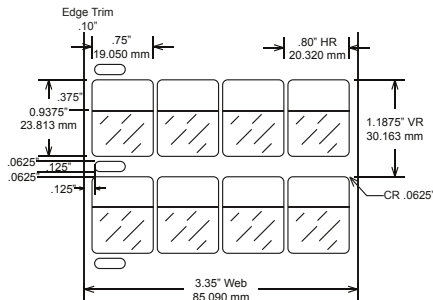

Part Number

TTL207-727-10

Material Description

Self-Laminating Vinyl with White Thermal Transfer Printable Area

TTRR™

A

1.900" x 5.940"
48.26 mm x 150.88 mm

TTL™ 208

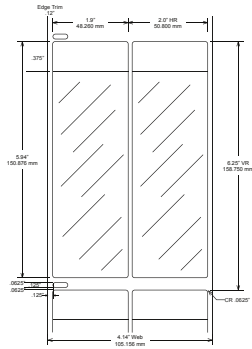

Part Number **Material Description** **TTRR™**

TTL208-727-1 Self-Laminating Vinyl with White Thermal Transfer Printable Area A

0.500" x 0.940"
12.70 mm x 23.88 mm

TTL™ 209

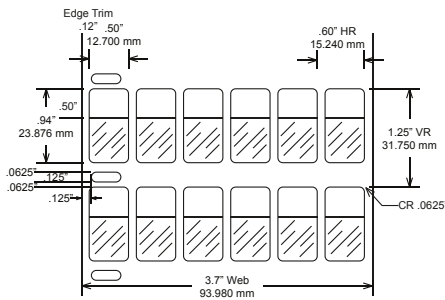

Part Number **Material Description** **TTRR™**

TTL209-727-10 Self-Laminating Vinyl with White Thermal Transfer Printable Area A

2.000" x 1.438"
50.80 mm x 36.51 mm

TTL™ 210

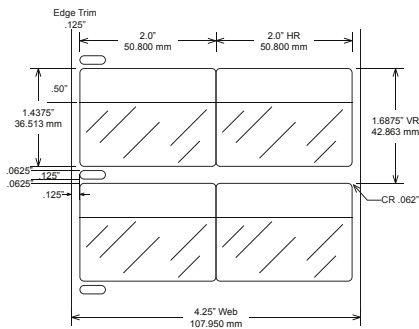

Part Number **Material Description** **TTRR™**

TTL210-727-2.5 Self-Laminating Vinyl with White Thermal Transfer Printable Area A

PACKAGING & SHIPPING LABELS

TTL™ 1-14 SERIES

IDENTCO TTL™ 1-14 series offers a wide variety of stock label options to fit your paper packaging needs. No need for a custom solution when you can choose a cost effective label from our selection.

TTL™ 1-14 series products work with the TTR™ series wax ribbons.



| Part Number | Perf. | Inches Width x Height | Millimeters Width x Height | Labels/Row | Qty/Roll | Case Qty |
|-------------|-------|--------------------------|-------------------------------|------------|----------|----------|
| TTL™ 2P-1 | • | 2.00" x 1.00" | 50.80 x 25.40 | 1 | 5,500 | 4 |
| TTL™ 3P | • | 3.50" x 1.00" | 88.90 x 25.40 | 1 | 5,500 | 4 |
| TTL™ 4 | | 3.00" x 2.00" | 76.20 x 50.80 | 1 | 2,900 | 4 |
| TTL™ 4P | • | 3.00" x 2.00" | 76.20 x 50.80 | 1 | 2,900 | 4 |
| TTL™ 5 | | 4.00" x 2.00" | 101.60 x 50.80 | 1 | 2,900 | 4 |
| TTL™ 5P | • | 4.00" x 2.00" | 101.60 x 50.80 | 1 | 2,900 | 4 |
| TTL™ 7P | • | 4.00" x 2.50" | 101.60 x 63.50 | 1 | 2,500 | 4 |
| TTL™ 8 | | 4.00" x 3.00" | 101.60 x 76.20 | 1 | 2,000 | 4 |
| TTL™ 8P | • | 4.00" x 3.00" | 101.60 x 76.20 | 1 | 2,000 | 4 |
| TTL™ 9P | • | 4.00" x 4.00" | 101.60 x 101.60 | 1 | 1,500 | 4 |
| TTL™ 10 | | 3.00" x 5.00" | 76.20 x 127.00 | 1 | 1,200 | 4 |
| TTL™ 10P | • | 3.00" x 5.00" | 76.20 x 127.00 | 1 | 1,200 | 4 |
| TTL™ 11 | | 4.00" x 6.00" | 101.60 x 152.40 | 1 | 1,000 | 4 |
| TTL™ 11P | • | 4.00" x 6.00" | 101.60 x 152.40 | 1 | 1,000 | 4 |
| TTL™ 12P | • | 4.00" x 6.50" | 101.60 x 165.10 | 1 | 900 | 4 |
| TTL™ 13 | | 3.00" x 1.00" | 76.20 x 25.40 | 1 | 5,500 | 8 |
| TTL™ 13P | • | 3.00" x 1.00" | 76.20 x 25.40 | 1 | 5,500 | 8 |
| TTL™ 14P | • | 4.00" x 1.00" | 101.60 x 25.40 | 1 | 5,500 | 8 |

UL/CSA NAMEPLATE LABELS

TTL™ 300 SERIES

HIGHLIGHTS

- Economical nameplates, rating plates, serialized barcode, and instructional labels
- Lifelong product identification
- **UL/CSA approved***

FEATURES

- Thermal transfer printable
- 10 stock sizes

TTL™ 300 series labels are cost-effective **UL/CSA recognized products** for nameplates, rating plates, serialized barcode, and instructional labels used on smooth surfaces. Contact an IDENTCO Application Engineer for recommendations on alternative materials for powder coated surfaces.

To achieve optimal print quality and **UL/CSA recognition**, IDENTCO TTL™ 300 series labels have been thoroughly tested and qualified to match a TTRR™ series ribbon.

***UL/CSA recognitions are contingent upon printing with the appropriate IDENTCO material and TTRR™ ribbon combination specified by Underwriters Laboratories and Canadian Standards Association testing.**

IN-STOCK MATERIALS INCLUDE:

- Gloss white polyester
- Matte white polyester
- Gloss silver polyester
- Matte silver polyester

Refer to pages 25–28 for charts and specifications

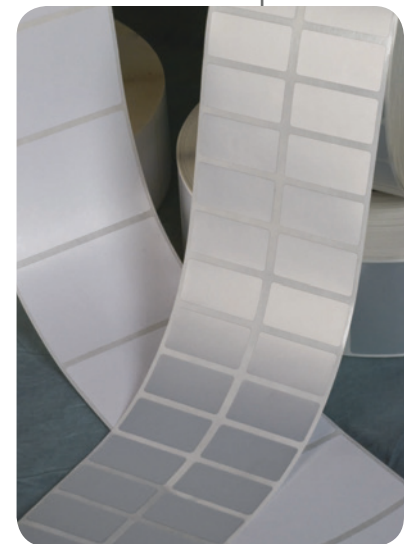

TTL™ 300 SERIES

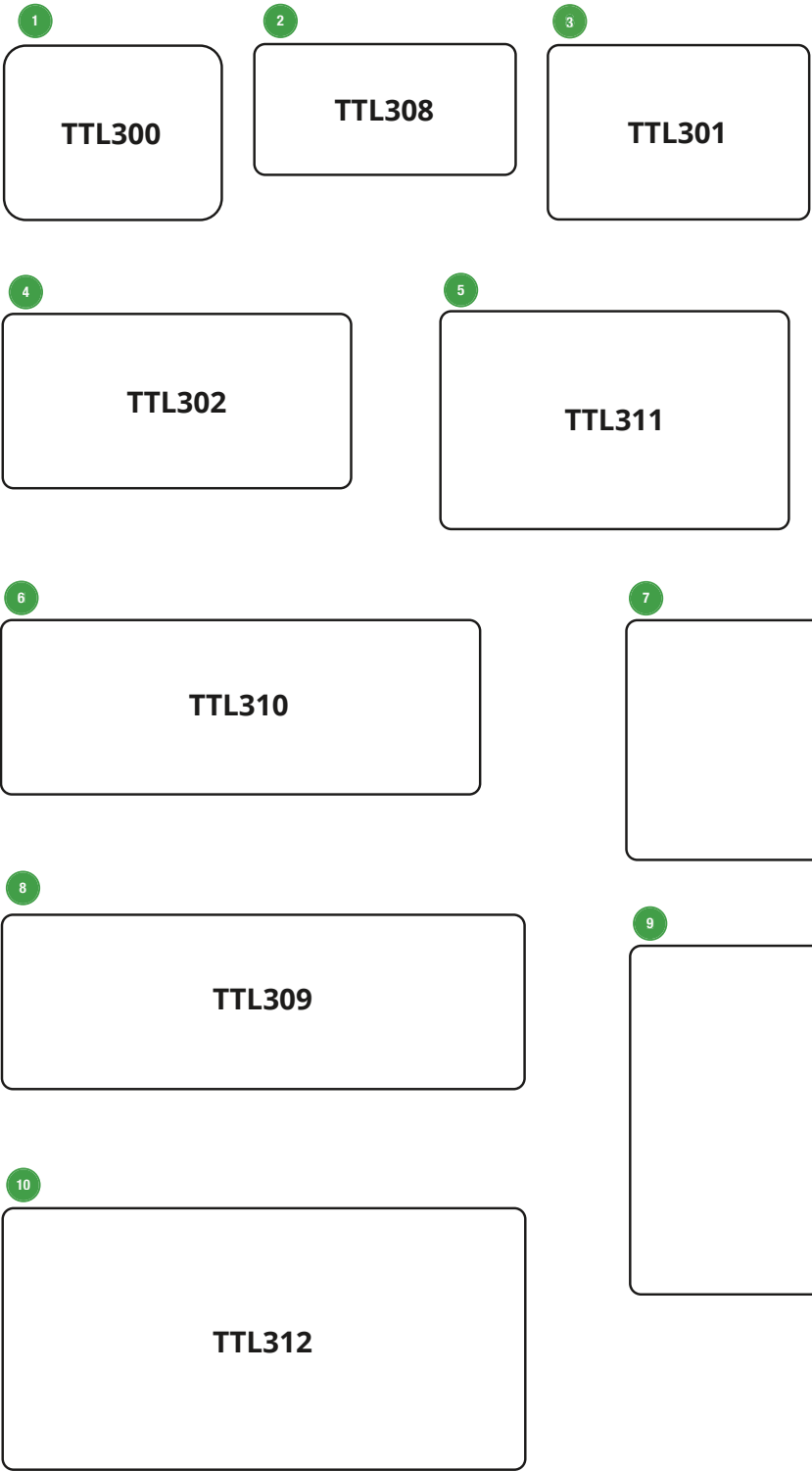

| Part # | Qty/roll (x1000) | Inches (w x h) | MM (w x h) | Labels/ row |
|-----------------|---------------------|-------------------|---------------|----------------|
| 1) TTL300-XXX- | 12 | 1.25 x 1.00 | 31.75 x 25.40 | 2 |
| 2) TTL308-XXX- | 10 | 1.50 x 0.75 | 38.10 x 19.10 | 2 |
| 3) TTL301-XXX- | 6 | 1.50 x 1.00 | 38.10 x 25.40 | 1 |
| 4) TTL302-XXX- | 6 | 2.00 x 1.00 | 50.80 x 31.80 | 1 |
| 5) TTL311-XXX- | 2.5 | 2.00 x 1.25 | 25.40 x 57.20 | 1 |
| 6) TTL310-XXX- | 5 | 2.75 x 1.00 | 69.85 x 25.40 | 1 |
| 7) TTL304-XXX- | 4 | 2.75 x 1.375 | 69.85 x 34.90 | 1 |
| 8) TTL309-XXX- | 5 | 3.00 x 1.00 | 76.20 x 25.40 | 1 |
| 9) TTL307-XXX- | 3 | 3.00 x 2.00 | 76.20 x 50.80 | 1 |
| 10) TTL312-XXX- | 2.5 | 3.00 x 1.50 | 76.20 x 38.10 | 1 |

Labels shown actual size

1.250" x 1.000"
31.75 mm x 25.40 mm

TTL™ 300

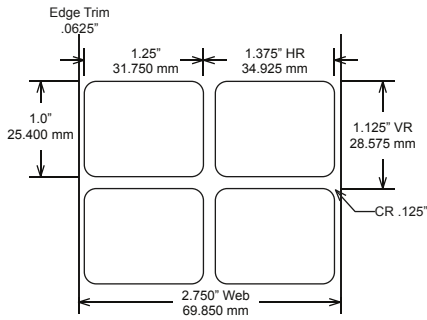

| Part Number | Material Description | TTRR™ |
|---------------|------------------------|-------|
| TTL300-700-12 | Gloss White Polyester | B,D |
| TTL300-701-12 | Matte White Polyester | B,D |
| TTL300-730-12 | Gloss Silver Polyester | B,D |
| TTL300-740-12 | Matte Silver Polyester | B,D |

1.500" x 1.000"
38.10 mm x 25.40 mm

TTL™ 301

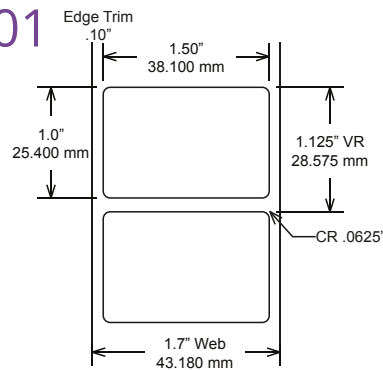

| Part Number | Material Description | TTRR™ |
|--------------|------------------------|-------|
| TTL301-700-6 | Gloss White Polyester | B,D |
| TTL301-701-6 | Matte White Polyester | B,D |
| TTL301-730-6 | Gloss Silver Polyester | B,D |
| TTL301-740-6 | Matte Silver Polyester | B,D |

2.000" x 1.000"
50.80 mm x 25.40 mm

TTL™ 302

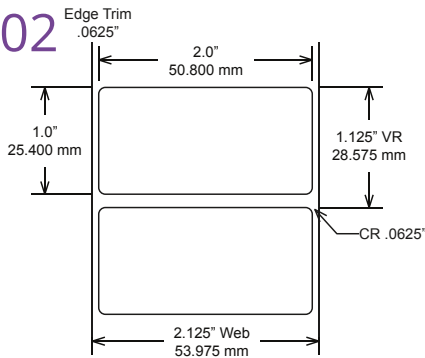

| Part Number | Material Description | TTRR™ |
|--------------|------------------------|-------|
| TTL302-700-6 | Gloss White Polyester | B,D |
| TTL302-701-6 | Matte White Polyester | B,D |
| TTL302-730-6 | Gloss Silver Polyester | B,D |
| TTL302-740-6 | Matte Silver Polyester | B,D |

2.750" x 1.375"
69.85 mm x 34.93 mm

TTL™ 304

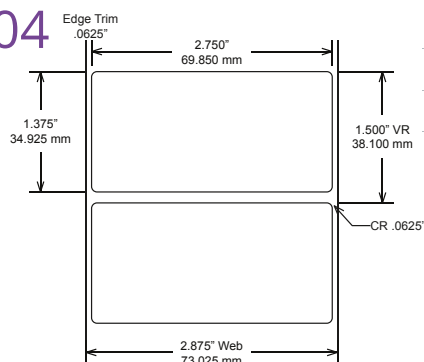

| Part Number | Material Description | TTRR™ |
|--------------|------------------------|-------|
| TTL304-700-4 | Gloss White Polyester | B,D |
| TTL304-701-4 | Matte White Polyester | B,D |
| TTL304-730-4 | Gloss Silver Polyester | B,D |
| TTL304-740-4 | Matte Silver Polyester | B,D |

3.000" x 2.000"
76.20 mm x 50.80 mm

TTL™ 307

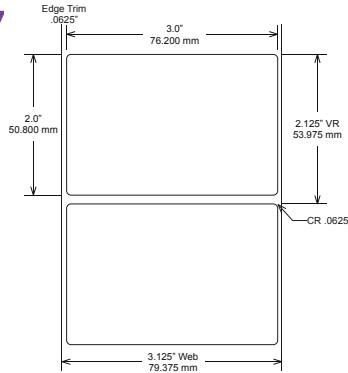

| Part Number | Material Description | TTRR™ |
|--------------|------------------------|-------|
| TTL307-700-3 | Gloss White Polyester | B,D |
| TTL307-701-3 | Matte White Polyester | B,D |
| TTL307-730-3 | Gloss Silver Polyester | B,D |
| TTL307-740-3 | Matte Silver Polyester | B,D |

1.500" x 0.750"
38.10 mm x 19.05 mm

TTL™ 308

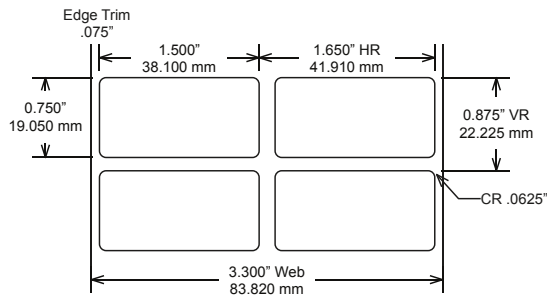

| Part Number | Material Description | TTRR™ |
|---------------|------------------------|-------|
| TTL308-700-10 | Gloss White Polyester | B,D |
| TTL308-701-10 | Matte White Polyester | B,D |
| TTL308-730-10 | Gloss Silver Polyester | B,D |
| TTL308-740-10 | Matte Silver Polyester | B,D |

3.000" x 1.000"
76.20 mm x 25.40 mm

TTL™ 309

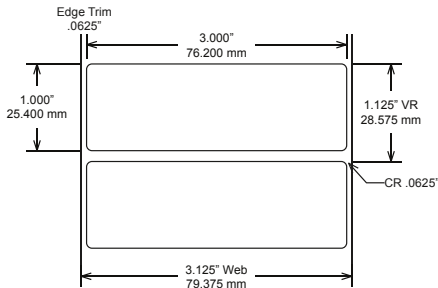

| Part Number | Material Description | TTRR™ |
|--------------|------------------------|-------|
| TTL309-700-5 | Gloss White Polyester | B,D |
| TTL309-701-5 | Matte White Polyester | B,D |
| TTL309-730-5 | Gloss Silver Polyester | B,D |
| TTL309-740-5 | Matte Silver Polyester | B,D |

2.750" x 1.000"
69.85 mm x 25.40 mm

TTL™ 310

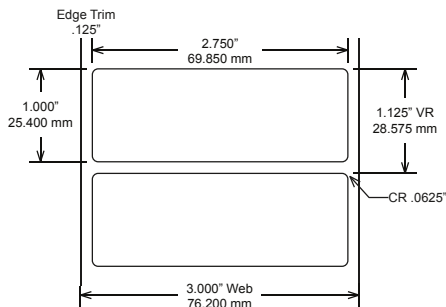

| Part Number | Material Description | TTRR™ |
|--------------|------------------------|-------|
| TTL310-700-5 | Gloss White Polyester | B,D |
| TTL310-701-5 | Matte White Polyester | B,D |
| TTL310-730-5 | Gloss Silver Polyester | B,D |
| TTL310-740-5 | Matte Silver Polyester | B,D |

2.000" x 1.250"
50.80 mm x 31.75 mm

TTL™ 311

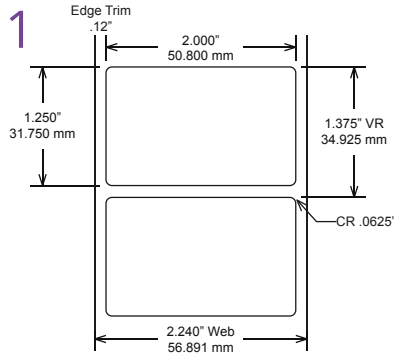

| Part Number | Material Description | TTRR™ |
|----------------|------------------------|-------|
| TTL311-700-2.5 | Gloss White Polyester | B,D |
| TTL311-701-2.5 | Matte White Polyester | B,D |
| TTL311-730-2.5 | Gloss Silver Polyester | B,D |
| TTL311-740-2.5 | Matte Silver Polyester | B,D |

3.000" x 1.500"
76.20 mm x 38.10 mm

TTL™ 312

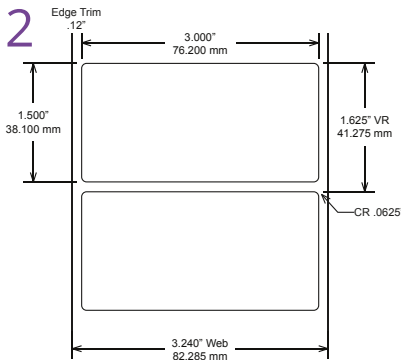

| Part Number | Material Description | TTRR™ |
|----------------|------------------------|-------|
| TTL312-700-2.5 | Gloss White Polyester | B,D |
| TTL312-701-2.5 | Matte White Polyester | B,D |
| TTL312-730-2.5 | Gloss Silver Polyester | B,D |
| TTL312-740-2.5 | Matte Silver Polyester | B,D |

your **#1 resource** for...
Printers



Pages 34-35

PRINT PROTECTION

GraphicLock™ TT For Thermal Transfer Printing

METAL NAMEPLATE ALTERNATIVE

HIGHLIGHTS

- Easy — print and apply!
- Cost Savings — no costly overlaminates
- Thermal transfer printable
- Harsh environment durability

FEATURES

- Print on-demand with IDENTCO ELP-A™ Series printers:
 - Graphics/Lettering
 - Serial Numbers
- Add graphics and variable information subsurface

QUALITY ENDORSEMENTS

- **UL/CSA recognized*** label and ribbon combinations
- RoHS compliant

***UL recognition is contingent upon printing with the appropriate IDENTCO material and TTRR™ ribbon combination as specified by Underwriters Laboratories testing.**

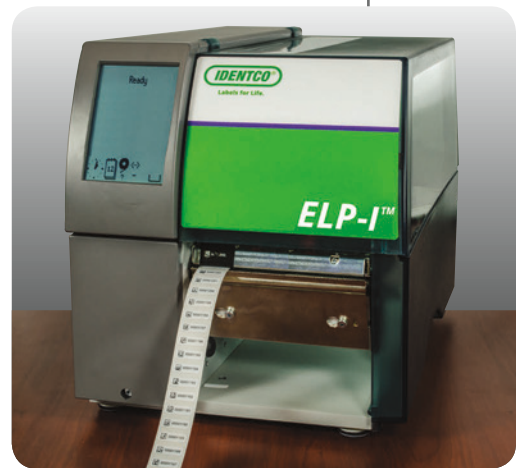

GraphicLock™

Fundamentally changes how IDENTCO prints and protects durable graphics



- Reduces the cost of subsurface printed labels without sacrificing performance
- Offers the ultimate in abrasion and chemical resistance
- Typical applications include: rating plates, branding labels, and warning and safety labels

IDENTCO GraphicLock™ using Avery Dennison TurnLock™ technology.

THERMAL TRANSFER RIBBONS

TTRR™ SERIES

HIGHLIGHTS

- Abrasion & solvent resistant
- Legend permanence
- Compatible with standard thermal transfer printers
- **UL/CSA approved***

FEATURES

- High performance resin and resin / wax
- Coated side in / side out



***The TTRR™ Series ribbon passes rigorous quality testing to meet the performance requirements of the TTL™ 100 and TTL™ 300 Series labels. These ribbons are ideal for products which require UL / CSA recognition. Recognition is contingent upon printing with the appropriate ribbon and material, while the critical bond between the two ensures lasting legend permanence.**

TTRR-D: ULTRA-DURABLE RESIN RIBBON - FILM CSO CSI

| | | | | |
|--------------|-------|-------------------|--------------|---|
| TTRR-D1.0Z | Black | 1.00" x 985 ft. | 25mm x 300m | • |
| TTRR-D1.57ZJ | Black | 1.57" x 1,476 ft. | 40mm x 450m | • |
| TTRR-D2.36ZJ | Black | 2.36" x 1,476 ft. | 60mm x 450m | • |
| TTRR-D3.27ZJ | Black | 3.27" x 1,476 ft. | 83mm x 450m | • |
| TTRR-D3.54ZJ | Black | 3.54" x 1,476 ft. | 90mm x 450m | • |
| TTRR-D4.33ZJ | Black | 4.33" x 1,476 ft. | 110mm x 450m | • |
| TTRR-D1.5F | Black | 1.50" x 1,181 ft. | 38mm x 360m | • |
| TTRR-D2.0F | Black | 2.00" x 1,181 ft. | 51mm x 360m | • |
| TTRR-D3.0F | Black | 3.00" x 1,181 ft. | 76mm x 360m | • |
| TTRR-D3.5F | Black | 3.50" x 1,181 ft. | 89mm x 360m | • |
| TTRR-D4.25F | Black | 4.25" x 1,181 ft. | 108mm x 360m | • |

TTRR-D (COLORS): ULTRA-DURABLE RESIN RIBBON - FILM CSO CSI

| | | | | |
|---------------|-------|-----------------|-------------|---|
| TTRR-D3.54RDZ | Red | 3.54" x 985 ft. | 89mm x 300m | • |
| TTRR-D3.54BLZ | Blue | 3.54" x 985 ft. | 89mm x 300m | • |
| TTRR-D3.54GRZ | Green | 3.54" x 985 ft. | 89mm x 300m | • |

TTRR-B: HIGH PERFORMANCE RESIN RIBBONS - FILM CSO CSI

| | | | | |
|--------------|-------|-------------------|--------------|---|
| TTRR-B1.0Z | Black | 1.00" x 985 ft. | 25mm x 300m | • |
| TTRR-B1.57ZJ | Black | 1.57" x 1,476 ft. | 40mm x 450m | • |
| TTRR-B2.52ZJ | Black | 2.52" x 1,476 ft. | 64mm x 450m | • |
| TTRR-B3.15ZJ | Black | 3.15" x 1,476 ft. | 80mm x 450m | • |
| TTRR-B3.50ZJ | Black | 3.50" x 1,476 ft. | 89mm x 450m | • |
| TTRR-B4.33Z | Black | 4.33" x 985 ft. | 110mm x 300m | • |
| TTRR-B4.33ZJ | Black | 4.33" x 1,476 ft. | 110mm x 450m | • |
| TTRR-B2.09F | Black | 2.06" x 1,182 ft. | 52mm x 360m | • |
| TTRR-B2.99F | Black | 2.99" x 1,182 ft. | 76mm x 360m | • |
| TTRR-B3.15F | Black | 3.15" x 1,182 ft. | 80mm x 360m | • |
| TTRR-B3.54F | Black | 3.54" x 1,182 ft. | 90mm x 360m | • |
| TTRR-B4.33F | Black | 4.33" x 1,182 ft. | 110mm x 360m | • |



THERMAL TRANSFER RIBBONS



TTR™ SERIES

HIGHLIGHTS

- Legend permanence
- Compatible with standard thermal transfer printers

FEATURES

- General purpose wax
- Coated side in / side out

IDENTCO TTR™ Series thermal transfer ribbons are ideal for general purpose applications, including packaging and shipping labels. IDENTCO offers a complete line of thermal transfer ribbons. Please contact an IDENTCO Application Engineer for recommendations on the selection of the appropriate ribbons.

TTR™ SERIES: GENERAL PURPOSE WAX RIBBONS

| Part Number | Color | Width | Length | Width | Length | CSO | CSI |
|-------------|-------|---------|-----------|---------|--------|-----|-----|
| TTR-1.57ZJ | Black | 1.57" x | 1,476 ft. | 40mm x | 450m | • | |
| TTR-2.36ZJ | Black | 2.36" x | 1,476 ft. | 60mm x | 450m | • | |
| TTR-3.15Z | Black | 3.15" x | 985 ft. | 80mm x | 300m | • | |
| TTR-3.26ZJ | Black | 3.26" x | 1,476 ft. | 83mm x | 450m | • | |
| TTR-3.5F | Black | 3.50" x | 985 ft. | 89mm x | 300m | | • |
| TTR-3.54ZJ | Black | 3.50" x | 1,476 ft. | 89mm x | 450m | • | |
| TTR-3.75Z | Black | 3.75" x | 985 ft. | 95mm x | 300m | • | |
| TTR-4.0F | Black | 4.00" x | 1,182 ft. | 102mm x | 360m | | • |
| TTR-4.25F | Black | 4.25" x | 1,182 ft. | 108mm x | 360m | | • |
| TTR-4.33Z | Black | 4.33" x | 985 ft. | 110mm x | 300m | • | |
| TTR-4.33ZJ | Black | 4.33" x | 1,476 ft. | 110mm x | 450m | • | |
| TTR-4.5F | Black | 4.50" x | 1,182 ft. | 114mm x | 360m | | • |
| TTR-5.12ZJ | Black | 5.12" x | 1,476 ft. | 130mm x | 450m | • | |
| TTR-6.0ZJ | Black | 6.00" x | 1,476 ft. | 152mm x | 450m | • | |
| TTR-6.5Z | Black | 6.50" x | 985 ft. | 165mm x | 300m | • | |



PRINT SERVICE BUREAU

VARIABLE PRINTING ALTERNATIVE

HIGHLIGHTS

- Eliminate the hassle of in-house printing
- Meet specific label needs, quality & efficiently
- Reduce in-house labor costs
- Reduce inventory costs and potential waste
- Quality is ASSURED
- Select from a wide range of stock labels for fast turnaround
- On Time Delivery – Have labels when and where you need them
- Guaranteed integrity of database

IDENTCO Print Service Bureaus are a cost effective, no hassle alternative to variable imprinting and barcoding of labels in-house. This service is ideally designed for sequential barcoding, whether your need is for linear or 2D barcodes.

For quick and easy fulfillment we can print your information on any of the stock label offerings in this catalog. For specific needs we can provide custom labels in any size or shape with a full array of label material choices.



CUSTOM BLANK LABELS

SPECIAL SHAPES, SIZES & DIE-CUTS

HIGHLIGHTS

- A limitless array of sizes and shapes
- Engineered for your specific application
- **UL/CSA approved***

FEATURES

- Precision die-cutting
- Thermal transfer printable

If your application cannot be addressed with one of our stock products, IDENTCO will custom manufacture a solution for you. Our project engineers will work with you to choose the exact components and processes to ensure your product will perform consistently.

IDENTCO can choose from over **500 material adhesive combinations** and over **10,000 in-house dies** to meet your needs and specifications. If custom tooling is required, IDENTCO will deliver a **cost saving quote in 30 minutes and your custom labels ready in under 72 hours**.

***UL recognition is contingent upon printing with the appropriate IDENTCO material and TTRR™ ribbon combination as specified by Underwriters Laboratories testing.**

IDENTCO has earned a reputation for being **FAST, RESPONSIVE and EASY** to work with. No matter what difficulties or challenges your company is facing, IDENTCO is an agile partner you can rely on to provide innovative solutions on time and on budget.

MATERIALS INCLUDE:

- Papers
- Polyolefins
- Polypropylenes
- Vinyls
- Polyesters
- Polyimides
- Synthetics



THERMAL TRANSFER PRINTERS

ELP-D™ & ELP-I™ SERIES

- Desktop Printer: ELP-D™
- Industrial Printer: ELP-I™

HIGHLIGHTS

- Extremely cost-effective printers
- Quickly integrates with production lines
- Readily accepts a broad array of labels and ribbons

ELP-D™

Quality thermal printing for any budget. An affordable and easy-to-use desktop printer for a wide variety of basic, lower-volume labeling applications, including wire-marking products.

ELP-I™

Perfect for economical, high-performance printing. Rugged and reliable for printing a wide variety of durable label formats in high-volume, demanding applications. A universal printer capable of multiple connectivity and label printing and presenting options making it an easy fit in any industrial operation.

Check us out on YouTube:

www.youtube.com/user/IDENTCOCorp



THERMAL TRANSFER PRINTERS

ELP-D™ & ELP-I™ SERIES

FEATURES

- Dpi conversion capability
- Multiple label presentation modes
- Multi connectivity (USB, Ethernet & Wireless, Serial)
- Stand-alone mode printing
- Micro-miniature printing
- ZPL emulation
- On-site service plans*
- 2 year warranty (Printhead and Parts)
- 5 Year extended warranty*
- Tech Support programs
- Unlimited phone support*

** Please call (800) 533-2559 and ask to speak to one of our Printer Application Engineers*



SPECIFICATIONS

| | ELP-D™ | ELP-I™ |
|---------------------------|-----------------------------------|--------|
| Print method | Thermal Transfer & Direct Thermal | |
| Print resolution dpi | 300 | 600 |
| Print speed up to mm/s | 127 | 250 |
| Print width mm | 106 | 106 |
| Media roll total up to mm | 127 | 205 |
| Label width mm | 20 -112 | 4 -112 |

IDENTCO presents the ELP™ series of thermal transfer printers. Faster ELP™ printers allow users to load, print, and change materials more efficiently. The ability to operate with a computer or network or in stand alone mode offers flexible printer operation.



PRINT & APPLY APPLICATOR

ELP-A™ SERIES

Labels not only need to be printed, but also applied. Manually applying labels at high rates is challenging and often results in inconsistent placement and poor adhesion performance. IDENTCO's ELP-A™ print and apply applicator is a cost effective solution that ensures consistent accuracy and adhesion performance at high rates. The applicator is designed to handle a broad range of sizes and shapes.

FEATURES

- Precise application tolerances of +/- .2mm (.007")
- Print and apply labels as small as 4mm x 4mm
- Large graphic display
- Application can be bottom to top, top to bottom or from either side
- Easily integrated into production lines or work cells
- Product can be presented to the applicator by hand or by automation
- Die-cast aluminum chassis provides a solid framework
- Ball-bearing transport rollers ensure highly accurate feeding of labels
- Easy to change printhead without adjustments or setups
- Host connection or stand alone operation

Speak to one of our Labeling Systems Engineers to discover more about the many ways IDENTCO can improve your quality and increase productivity.

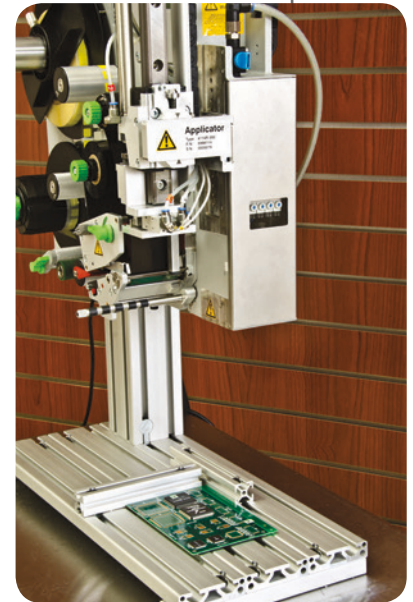

SPECIFICATIONS

ELP-A™

| | |
|------------------------------------|-----------------------------------|
| Print method | Thermal Transfer & Direct Thermal |
| Print resolution dpi | 600 |
| Print speed up to mm/s | 100 |
| Print width mm | 57.0 |
| Media roll total diameter up to mm | 205 |
| Label width mm | 4-58 |

PRECISION LABELS FOR AUTOMATIC APPLICATIONS

AUTO-APPLY LABELS

HIGHLIGHTS

- Available for a wide array of automation systems
- Perfect for static reduction
- **UL approved***

FEATURES

- Precision die-cutting
- Quick release film liners
 - Anti-static dissipative
 - Dust-free
- Reel-e™ spools
 - Robust design
 - Anti-static dissipative
 - RoHS compliant



As an industry leader, IDENTCO understands high speed automatic application equipment requires a precisely manufactured part for static free assembly. With over 30 years experience, IDENTCO can design and produce labels for all major automation equipment.

To eliminate damaging static build-up in the production area, IDENTCO engineered the REEL-e™.

The REEL-e™ is recyclable, 100% RoHS compliant and made of an electrostatic dissipative plastic material that aids in the elimination of static build-up. This ensures static-free delivery of labels and die-cut parts to feeders and auto-apply machines.

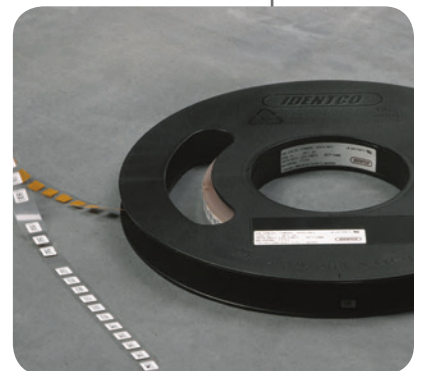

DID YOU KNOW...

* UL recognition approval is contingent upon printing your IDENTCO labels with the appropriate IDENTCO TTRR™ series thermal transfer ribbon? These combinations have been tested & approved by Underwriters Laboratories.

AUTOMATION EQUIPMENT

PRE-PRINTED LABEL PRESENTER

FEATURES

- Automatically places labels using existing pick-and-place equipment
- On machine placement similar to any other feeder
- Maximum label placement accuracy
- Flexible solutions for circuit board applications
- Saves time and money with low maintenance costs
- Optimal performance when used with IDENTCO Reel-e™ label spools and quick release liners

Earning a reputation as “the best auto-apply label supplier” in the marketplace, IDENTCO leads the industry by providing innovative automation solutions. We teamed up with Hover-Davis to offer the most flexible alternative for placing labels automatically with existing pick and place equipment.

IDENTCO helps customers optimize their investment in automation technologies by improving placement accuracy and speed of the label process. These skillfully engineered label feeders combined with the appropriate auto apply labels are designed to exceed your labeling requirements. The pre-printed label presenter places the label like any other SMT component to help streamline your labeling process.

The Hover-Davis label feeder has a modular design consisting of two basic assemblies. The first element is the Label Presenter (LP), which provides the mechanical and electrical interface to the host machine. The second element is the Label Specific Module (LMG) designed specifically to peel and present the label.

Combining IDENTCO industry expertise with a Hover-Davis custom component delivery system provides additional value to manufacturers seeking to perfect operations and data delivery control through labeling.

LPS SERIES PRESENTERS FOR:

- Assembleon
- Universal
- Panasonic
- Siemens
- MYDATA
- Juki
- Fuji
- Samsung
- Yamaha

IDENTCO is an authorized distributor for **HOVER-DAVIS**

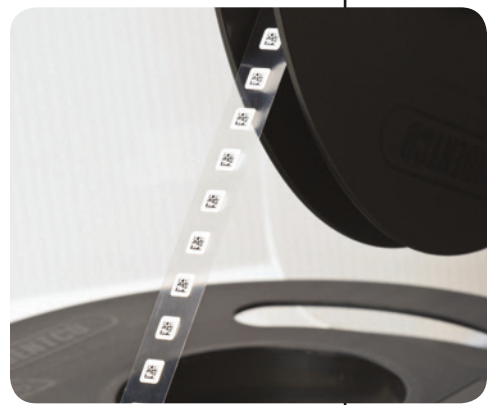

IMS SERIES HEAT SHRINK WIRE MARKERS

VISUAL DATA MANAGEMENT FOR TOUGH ENVIRONMENTS

HIGHLIGHTS

- Military grade standards
- 3:1 shrink ratio standard (2:1 available)
- Thermal transfer printable
- Chemical and abrasion resistance
- Custom colors and sizes available

FEATURES

- Multiple shrink ratios
- Permanent identification sleeves
- Made from a flame retardant, radiation cross-linked heat shrinkable polyolefin
- Quick cool down time for heat sensitive areas
- Optimal performance when printed with the recommended IDENTCO TTR™-D ribbon and printer
- Resistant to harsh chemicals, abrasion, as well as many fuels & oils



IDENTCO MARKING SYSTEM 3:1 SHRINK RATIO

| Part Number | Size in. | Size mm |
|----------------------|----------|---------|
| IMS-2.0-.094SM-2.5W | 3/32" | 2.4 |
| IMS-2.0-.125SM-2.0W | 1/8" | 3.2 |
| IMS-2.0-.188SM-1.5W | 3/16" | 4.8 |
| IMS-2.0-.250SM-1.5W | 1/4" | 6.4 |
| IMS-2.0-.375SM-1.0W | 3/8" | 9.5 |
| IMS-2.0-.500SM-0.5W | 1/2" | 12.7 |
| IMS-2.0-.750SM-0.5W | 3/4" | 19.1 |
| IMS-2.0-1.00SM-0.25W | 1" | 25.4 |
| IMS-2.0-1.50SM-0.25W | 1 1/2" | 38.1 |



ASSUME QUALITY, EXPECT PERFECTION.

HIGHEST QUALITY GLOBAL PRODUCTION

With IDENTCO quality-control safeguards we are able to ensure consistent, accurate production globally. To achieve this, we use the same equipment, materials, inks, and procedures in all of our facilities. So no matter where we produce your labels, they look and perform the same every time.

All of our locations are able to meet the same branding, performance, and regulatory specifications. We provide excellent color-matching capabilities and accuracy, as well as a fully-equipped testing laboratory with superior quality control processes. It's just another way IDENTCO can ensure our customers consistent success.

QUALITY MANAGEMENT SYSTEMS



ISO-CERTIFIED Quality Management System

ISO 9001 - QUALITY MANAGEMENT STANDARD
TS 16949 - AUTOMOTIVE MANAGEMENT STANDARD
ISO 14001 - ENVIRONMENTAL MANAGEMENT STANDARD

AGENCY RECOGNITIONS



UL: UNDERWRITERS LABORATORIES
UL-Authorized Label Supplier Program
UL-Recognized Label and Ribbon Combinations

CSA: CANADIAN STANDARDS ASSOCIATION



CENTER OF EXCELLENCE

• • • **NOTES** • • •

A large rectangular area filled with a grid of dashed lines, intended for writing notes. The grid consists of 20 columns and 30 rows of small squares.



Labels for Life.

www.identco.com

**UNITED STATES
HEADQUARTERS**

28164 W. Concrete Drive
Ingleside, IL 60041
Phone: +1 (815) 385 - 0011
Fax +1 (815) 385 - 0359

**MEXICO
MONTERREY**

Carr. a Laredo Km. 16.5 Interior
14B, Col. Moisés Sáenz, 66613
Apodaca, Nuevo Leon
Phone: +52 (81) 8008 - 0438

**GERMANY
FRANKFURT**

Güterbahnhofstrasse 3-7
63450 Hanau
Phone: +49 (6181) 440 830 - 0
Fax: +49 (6181) 440 830 - 99

**PRC
HONG KONG**

Unit 1708, 17/F, 9 Wing Hong St.
Cheung Sha Wan, Kowloon
Phone: +852 2959 2156
Fax: +852 2959 2019

**MALAYSIA
PENANG**

Suite 163E, Level 16, Room 1602
Hunza Tower Gurney Paragon
Jalan Kelawei, Georgetown
10250 Penang
Phone: +6012 466 - 0866