



Industrial Ingenuity Lives Here.



The Techcon Story

In the evolving world of manufacturing, Techcon is delivering smarter, cleaner, more durable solutions.

Since 1961, our fluid and adhesive dispensing products have been renowned for their superior accuracy and durability, offering customers both improved industrial hygiene and enhanced productivity.

Moving forward, our innovation road map pushes these boundaries even further, with the introduction of intelligent solutions such as an automatic robotic dispensing system and equipment with homeostatic dispensing capabilities. These new developments reduce human error and further increase precision, while providing smart IoT features such as uploadable instructional files and remote monitoring/troubleshooting.

Our products are backed by an expert engineering team that can solve the toughest manufacturing problems in a range of industries, from aerospace, military and material packaging to industrial assembly, medical devices and electronics.

We're Techcon, an OK International company.

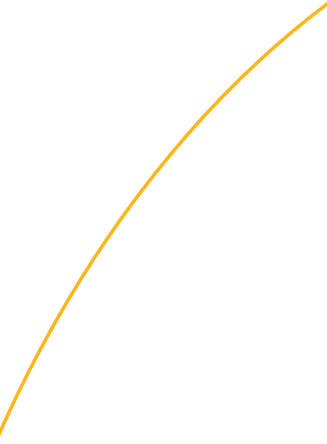

Table of Contents

- 
- ② Application Table of Contents
 - ③ TS250/TS350 Dispenser/Controller
 - ④ 700 Series Dispensing Components
 - ⑥ Premium Dispensing Tips
 - ⑧ 700 and 400 Series Dispensing Components
 - ⑩ Dispensing Tips
 - ⑫ Bench-Top Dispensing Robot
 - ⑬ Smart Dispensing Robot
 - ⑭ TS9200D Series Jet Tech
 - ⑮ TS8100 PC Pump
 - ⑯ TS5000DMP-DCX Rotary Microvalve
 - ⑰ TS7000-DCX (IMP) Rotary Valves
 - ⑱ TS5620 Series Diaphragm Valves
 - ⑲ TS5624DMP Disposable Material Path Diaphragm Valve
 - ⑳ TS5400 Needle Valves
 - ㉑ TS941/TS5322 Spool Valves
 - ㉒ TS1212/1201 Pinch Tube Valves
 - ㉓ TS5500 Spray Valves
 - ㉔ TS500 Smart Valve Controllers
 - ㉖ TS1254/1258 Pressure Pot
 - ㉗ Valve Application Guide
 - ㉘ Fluid Dispensing Valves
 - ㉙ Fluid Line Assemblies
 - ㉚ Cartridges and Accessories
 - ㉛ Disposable Nozzles and Dispensing Tip Adapters
 - ㉜ Dispensing Guns and Components
 - ㉝ TS6500 Techkit Cartridge Mixers
 - ㉞ Techkit Components
 - ㉟ Tutorial - Time-Pressure Dispensing
 - ㊱ Valve Diagrams

Application Table of Contents

Find the right products for your applications



Bonding With Cyanoacrylate Adhesives (CA)

CA is a very frequently used adhesive in generic bonding applications and it is best used with a moisture resistant dispensing system. The TS5622VU Diaphragm valve along with the TS550R controller and TS1258 pressure pot is a perfect system for this application. **TS5622VU (page 18), TS550R (page 25), TS1258 (page 26)**

Domed Logo Badges Application (Doming)

Consumer and business products often display the manufacturer's name on a sticker that is encapsulated underneath a dome of fluid. This is called "Doming" and is commonly used as this adds a better "look and feel" to the product. The TS5622VU-DVD with the TS550R controller and TS1258 pressure pot is a perfect system for this application. **TS5622VU-DVD (page 18), TS550R (page 25), TS1258 pressure pot (page 26)**

Microdot Adhesive Dispensing

Most medical device manufacturing applications require a dispensing system that can provide a highly repeatable dispensing of UV adhesives. With the unique needle shut off design inside the dispensing tip, the TS5440 Microshot needle valve is the perfect choice for these applications. The TS550R controller is recommended for this valve. **TS5440 Microshot needle valve (page 20), TS550R controller (page 25)**

Spray Conformal Coating Application

The TS5540 Series spray valve along with the TS560R controller and the TS1258 pressure pot is an ideal system to spray conformal coating material on the surface of an assembled printed circuit board to provide protection against moisture, dust and corrosion from extreme environments. **TS5540 Series spray valve (page 23), TS560R controller (page 25), TS1258 pressure pot (page 26)**

Gasketing Application

When a high throughput or large shot size is required for gasketing or similar "Form-in-place-gasket" applications, the TS941 Series spool valve along with the TS550R controller is the recommended system choice. Whether the fluid is fed from a cartridge or pail pump, the TS941 Series will dispense accurately and consistently through a dispensing nozzle or dispensing tip.

For finer deposit control of sealing material, the TS5322 Series mini spool valve with the TS550R controller is recommended. **TS941 Series spool valve (page 21), TS550R controller (page 25), TS5322 Series mini spool valve (page 21)**

Dam Writing Application

The TS7000 Series rotary valve along with the TS570R controller is an ideal dispensing system to dispense the "Dam" around the die of an integrated circuit (i.c.) as an alternative method to using the pre-form molded design. **TS7000DCX Series rotary valve (page 17), TS570R controller (page 25)**

Plural Component Material Dispensing

Plural component material dispensing is no longer a problem when using a Disposable Material Path valve. When the 2-component material starts to cure, just throw away the valve wetted parts. It takes less than 1 minute to replace with new parts.

For low viscosity material, the TS1212 pinch tube valve along with the TS550R controller is recommended. For medium to high viscosity material with high repeatability rate requirement, the TS5000DMP valve with the TS570R controller is suitable. **TS1212 pinch tube valve (page 22), TS550R controller (page 25), TS5000DMP-DCX valve (page 16), TS570R controller (page 25)**

Solder Paste Dispensing

Solder paste is the most difficult material to dispense. The TS5000DMP-DCX Series rotary valve is designed specifically to dispense solder paste without clogging and separation. Dot size as small as 0.010" (0.254mm) can be dispensed consistently. A majority of automated dispensing systems incorporate the TS5000DMP-DCX Series valve for solder paste dispensing. **TS5000DMP-DCX Series rotary valve (page 16), TS570R Controller (page 25)**

TS250 Series Digital Dispenser/Controller

The TS250 Series Dispenser/Controller dispenses low, medium and high-viscosity fluids accurately and consistently. These systems are economical, highly accurate and repeatable micro-air dispensing systems. These user friendly fluid dispensing systems include digital timer with rotary control time knob for easy setup and a vacuum control for all viscosities of fluids.

Packaged ready to use with a universal power supply, foot switch, air hose, sample tips, syringe barrel and adapter. Features a small footprint and is lightweight.

Available in two versions of operating pressure: 0 to 100 psi (0-6.9 bar) for general applications and 0 to 15 psi (0-1.0 bar) for specific low viscosity applications.



TS350 Series Digital Dispenser/Controller

The TS350 Series Dispenser/Controller is equipped with digital timer, pressure and vacuum read out on a large LCD. The firmware provides the option of programming up to 10 varied, sequenced or individual shots. It is intuitive to use, dispenses low, medium and high-viscosity fluids accurately and consistently.

The TS350/355 Series includes a vacuum-driven “suck-back” to control material “tailing” and waste and to control drips of fluid between dispense cycles. These systems have user programmable manual (purge) and automatic dispense cycle settings (program and time) and they feature a “Teach Mode” for determining the dispensing time required when dispensing output is unknown.

Packaged ready to use with a universal power supply, foot switch, air hose, sample tips, syringe barrel and adapter. Features a small footprint and is lightweight.

Available in two versions of operating pressure: 0 to 100 psi (0-6.9 bar) for general applications and 0 to 15 psi (0-1.0 bar) for specific low viscosity applications.



Specifications

Part Number	TS250 Series	TS350 Series
TS250/TS350 Dispenser/Controller	0-100 psi (0-6.9 bar)	
TS255/TS355 Dispenser	0-15 psi (0-1.0 bar)	
Specifications & Dimensions		
Cabinet Dimensions	6"W (152mm) x 6.5"L (152mm) x 7.0"H (178mm)	
Weight	2.6 lb. (1.2 kg)	
Cycle Rate	600 cycle/minute	1200 cycle/minute
Timing Range	0.020-60.000 seconds	0.008-60.000 seconds
Timing Repeat Tolerances	+/- 0.001%	
Input Voltage	100-240 VAC	
Input Frequency	50-60 Hz	
Cycle Mode	TIMED, PURGE	TIMED, INTERRUPT, TEACH, PURGE
Meets or exceeds	CE, TUV-GS and NRTL	
Warranty	1 year	



700 Series

Dispensing Components



700 Series Syringe Barrel Kits

For your convenience these syringe barrels and white wiper pistons are packaged together without pistons inserted. Kits with blue pistons are also available. Sold in bulk and packs of 50.

Syringe Barrel Kits With White Wiper Pistons

Size	Natural	Amber	Black
3 cc	7030LL1NW-1000	7030LL1DW-1000	7030LL1BW-1000
5 cc	7050LL1NW-1000	7050LL1DW-1000	7050LL1BW-1000
10 cc	7100LL1NW-1000	7100LL1DW-1000	7100LL1BW-1000
30 cc	7300LL1NW-500	7300LL1DW-500	7300LL1BW-500
55 cc	7550LL1NW-250	7550LL1DW-250	7550LL1BW-250

Syringe Barrel Kits With Blue Wiper Pistons

Size	Natural
3 cc	7030LL1NBL-1000
5 cc	7050LL1NBL-1000
10 cc	7100LL1NBL-1000
30 cc	7300LL1NBL-500
55 cc	7550LL1NBL-250

700 Series Air Powered Pistons

Spread the pressure evenly across, using a piston for consistent dispensing of even high viscosity material. Easy Flow pistons (blue) require less pressure to dispense and prevent air from becoming entrapped during the dispense process. Tight fit Wiper pistons (white) provide a complete seal for low viscosity fluid. Loose fit straight wall pistons (red) prevent stringing and bouncing when dispensing high viscosity material. Sold in bulk and packs of 50. Made from polyethylene.

Size	Wiper Piston (White)	Straight Wall Piston (Red)	Easy Flow Piston (Blue)
3 cc	7030009W-1000	7030006R-1000	7030007BL-1000
5 cc	7050009W-1000	7050006R-1000	7050007BL-1000
10 cc	7100009W-1000	7100006R-1000	7100007BL-1000
30-55 cc	7300009W-1000	7300006R-1000	7300007BL-1000

700 Series Dispensing Components

Our 700 Series Premier dispensing components are silicone and chloride free and designed to work with industry standard equipment. 700 Series dispensing components ensure accuracy, repeatability and productivity.

700 Series Syringe Barrels

Unique ultra-low draft construction of inner diameter yields high accuracy and stability. They are comprised of industry compliant silicone and chloride free, low friction polypropylene. Available in three different colors: Natural for most generic applications, amber provides protection of UV/visible light block (up to 520nm), but with the ability to see material inside the barrel; and black for total light block. Sold in bulk and packs of 50.

Size	Natural	Amber	Black
3 cc	7030LL1N-1000	7030LL1D-1000	7030LL1B-1000
5 cc	7050LL1N-1000	7050LL1D-1000	7050LL1B-1000
10 cc	7100LL1N-1000	7100LL1D-1000	7100LL1B-1000
30 cc	7300LL1N-500	7300LL1D-500	7300LL1B-500
55 cc	7550LL1N-250	7550LL1D-250	7550LL1B-250

700 Series Syringe Barrel Dimensions

Capacity	Overall Length A inches/mm	Outside Diameter B inches/mm
3 cc	2.96/75.18	0.46/11.56
5 cc	2.83/71.9	0.59/14.99
10 cc	3.58/90.9	0.72/18.29
30 cc	4.66/118.36	0.99/25.15
55 cc	6.91/175.51	1.01/25.65

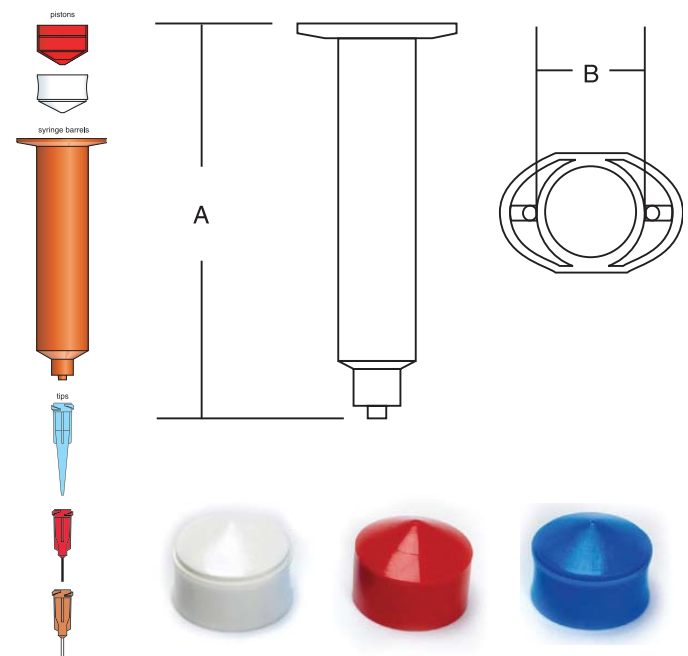

700 Series Receiver Head Assembly

Receiver Head Assemblies are the connecting link between time/pressure controllers and syringe assemblies. These assemblies provide a safe connection for accident proof dispensing. Available with 3 or 6 feet (0.9 - 1.8 meters) of tubing. Consists of receiver head with Viton O-ring, tubing and male quick connector. Sold individually. Made of Delrin®.



Size	3' (0.9m) Hose	6' (1.8m) Hose	No Hose
3 cc	70303RHB	70306RHB	70300RHR
5 cc	70503RHB	70506RHB	70500RHR
10 cc	71003RHB	71006RHB	71000RHR
30/55 cc	73003RHB	73006RHB	73000RHR

In-Line Fluid Filter

Attach the fluid filter to the receiver head to prevent fluid from being pulled back from the syringe barrel into the dispenser.

Part No.	Description
881-000-000	In-line fluid filter kit
TSD800-11	In-line fluid filter only
Housing Material	Polypropylene
Filter Media	0.2um PTFE
Operating Pressure	75 psi max.

Replacement O-rings for Receiver Head

Sold in packs of 10.



SIZE	EPR O-ring	Viton O-ring
3 cc	P3015EPK	P3019VPK
5 cc	P3016EPK	P3020VPK
10 cc	P3017EPK	P3021VPK
30/55 cc	P3018EPK	P3022VPK

The Receiver Head is installed with Viton O-ring.

700 Series Tip Cap

Designed to seal the syringe barrel tip during storage and shipment. Fits all syringe barrel sizes. Sold in bulk and packs of 50. Made from polypropylene.



Part No.	Description
7015LL-1000	Tip Cap Double Helix Thread Orange
TE7015LB-1000	Tip Cap Double Helix Thread Black

Stand up Tip Cap

Designed for easy attachment with large flat diameter at the base to allow for the syringe barrel to stand upright. Sold in bulk and packs of 50. Made from Polypropylene.



Part No.	Description
7015STC-1000	Blue Stand up Tip Cap

700 Series End Caps

Designed to seal large end of the syringe barrel to ensure no contaminants come in contact with material during storage and shipment. Standard color is blue. Made from Polypropylene. Sold in bulk and packs of 50.



Size	End Cap
3 cc	703000CB-1000
5 cc	705000CB-1000
10 cc	710000CB-1000
30/55 cc	730000CB-1000

TS700 Series Manual Syringe Gun

Lightweight syringe barrel applicator gun provides excellent control for medium/high viscosity material. Easy to use. No dripping or mess.



Size	Manual Syringe Gun
10 cc	TS710SG
30 cc	TS730SG
55 cc	TS755SG
SIZE	REPLACEMENT ROD
10 cc	71000ROD
30 cc	73000ROD
55 cc	75500ROD-C

Finger Switch Assembly

Use the Finger Switch with Techcon's dispensers and syringes in place of a foot pedal. Provides control at your finger tip.



Part No.	Description
DX9010	Finger Switch Assembly for TS Series Dispenser

TE Series & Teflon Tips

Premium Dispensing Tips



TE Series - Dispensing Tips

TE Series Dispensing Tips

The TE series consist of a stainless-steel cannula with a double helix polypropylene hub.

This premium line of dispensing tips is burr-free, and has an electro-polished cannula for unobstructed and consistent material flow. In addition, they are silicone and chloride free. Sold in bulk and packs of 50.

TE Dispensing Tips				
	1/4" (6.35mm)	1/2" (12.7mm)	1" (25.4mm)	1-1/2" (38.1mm)
Gauge				
14		TE714050-1000	TE714100-1000	TE714150-1000
15		TE715050-1000	TE715100-1000	TE715150-1000
18	TE718025-1000	TE718050-1000	TE718100-1000	TE718150-1000
20	TE720025-1000	TE720050-1000	TE720100-1000	TE720150-1000
21	TE721025-1000	TE721050-1000	TE721100-1000	TE721150-1000
22	TE722025-1000	TE722050-1000	TE722100-1000	TE722150-1000
23	TE723025-1000	TE723050-1000	TE723100-1000	TE723150-1000
25	TE725025-1000	TE725050-1000		
27	TE727025-1000	TE727050-1000		
30	TE730025-1000	TE730050-1000		
32	TE732025-1000			
34	TE734025-1000			

Color Coding and Gauge

For TE Series and TE Bent Dispensing Tips.

Color	Gauge	I.D. (")	I.D. (mm)
Olive	14	0.063	1.600
Amber	15	0.054	1.371
Green	18	0.033	0.838
Pink	20	0.024	0.610
Purple	21	0.020	0.508
Blue	22	0.016	0.406
Orange	23	0.013	0.330
Red	25	0.010	0.254
Clear	27	0.008	0.203
Lavender	30	0.006	0.152
Yellow	32	0.004	0.102
Lime Green	34	0.0037	0.095

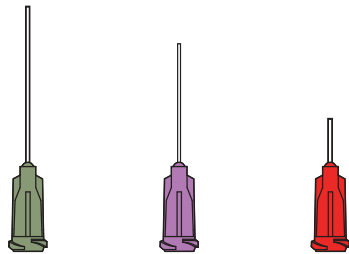

TE Bent Dispensing Tips

These TE bent tips are precision bent at 45° and 90° angles. Perfect for dispensing fluid in hard to reach places. Sold in packs of 50.

TE Bent Dispensing Tips			
Gauge	1/2" (12.7mm)		1-1/2" (38.1mm)
	90°	45°	45°
14	TE714050B90PK	TE714050B45PK	TE714150B45PK
15	TE715050B90PK	TE715050B45PK	
18	TE718050B90PK	TE718050B45PK	TE718150B45PK
20	TE720050B90PK	TE720050B45PK	
21	TE721050B90PK	TE721050B45PK	TE721150B45PK
22	TE722050B90PK	TE722050B45PK	
23	TE723050B90PK	TE723050B45PK	
25	TE725050B90PK	TE725050B45PK	
27	TE727050B90PK	TE727050B45PK	
30	TE730050B90PK	TE730050B45PK	

Teflon® Lined Tips

Teflon® lined tips are ideal for use with low viscosity fluids and cyanoacrylates (super glue) material. Benefits of using this Teflon® lined tip include resist cyanoacrylate clogging and prevent damage to substrates.

Teflon® lined tips feature a double helix polypropylene color hub and a rigid Teflon® crimped lining that protrudes approximately 1/8" (3.17mm) from the inside of a stainless steel tube. Sold in packs of 50.



Teflon® Lined - Dispensing Tips

Teflon® Lined Tips				
Hub Color	1/2" (12.7mm)	1" (25.4mm)	Tip ID	Crimp ID
Gray	TF720050PK	TF720100PK	0.024" (0.61mm)	0.023" (0.58mm)
Pink	TF725050PK	TF725100PK	0.011" (0.28mm)	0.006" (0.15mm)

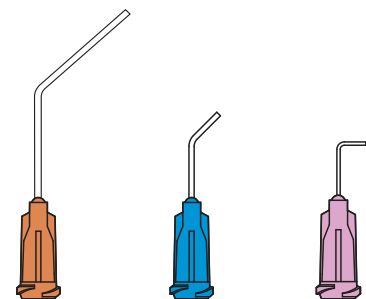

TT Series Dispensing Tips

The tapered tip prevents blockage and increase the flow of high viscosity material. Standard tips are molded in high density polyethylene with UV light block additive. Rigid tips are molded in polypropylene with opaque color. Sold in bulk and packs of 50.

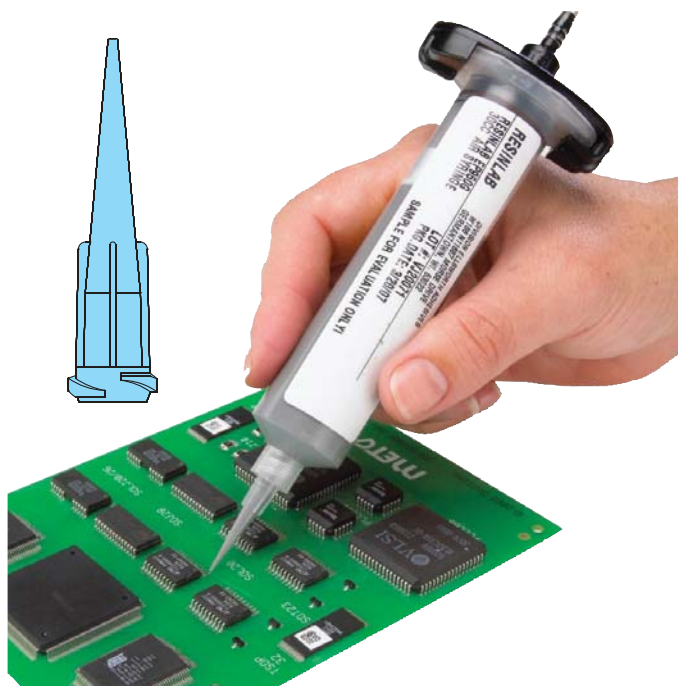

Gauge	Color	Standard TT Tips	Rigid TT Tips
14	Olive	TT14-DHUV-1000	TT14-RIGID-1000
16	Grey	TT16-DHUV-1000	TT16-RIGID-1000
18	Green	TT18-DHUV-1000	TT18-RIGID-1000
20	Pink	TT20-DHUV-1000	TT20-RIGID-1000
22	Blue	TT22-DHUV-1000	TT22-RIGID-1000
25	Red	TT25-DHUV-1000	TT25-RIGID-1000
27	Clear	TT27-DHUV-1000	TT27-RIGID-1000

TS-P Plastic Dispensing Tips

Flexible tips allow access to hard to reach areas and allow you to “customize” the length. Ideal for CA applications. 1 1/2” length. Sold in bulk and packs of 50. Made from polypropylene.

Gauge	Color	TS-P Dispensing Tips
15	Grey	TS15P-1-1/2-500
16	Brown	TS16P-1-1/2-500
18	Pink	TS18P-1-1/2-500
20	Yellow	TS20P-1-1/2-500
22	Black	TS22P-1-1/2-500
25	Red	TS25P-1-1/2-500

BT Series Dispensing Tips

Use these double helix Brush Tips for “spread” applications such as glues and other materials. Soft brush is made of Red Sable. Stiff brush is made of Nylon. Sold in packs of 12.



Gauge	Soft Bristle	Stiff Bristle
16	BT16-SOFTPK	BT16-STIFFPK
18	BT18-SOFTPK	BT18-STIFFPK
22	BT22-SOFTPK	BT22-STIFFPK

Dispensing Tip Kit

Decide for yourself which tip to use. This kit contains a variety of the most popular 700 Series tips to let you test different tips to find the ones that fit your needs.



Part No.	Description
TNOODKIT	Dispensing Tip Kit

700 & 400 Series

Dispensing Components

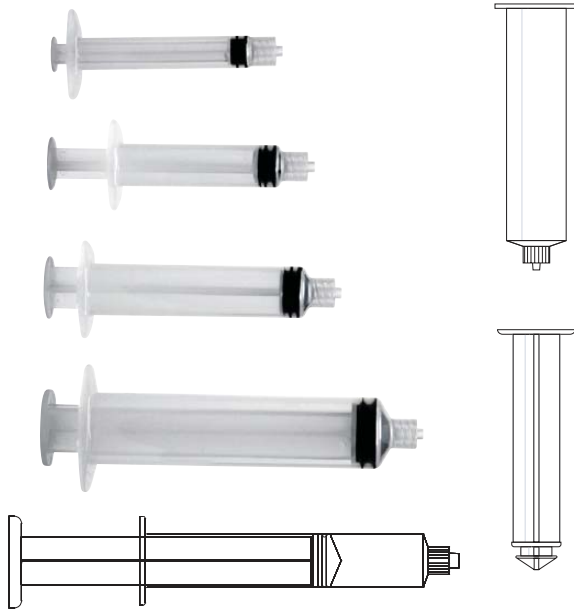

Manual Plungers & Pistons 700 Series Syringe Barrels

The new manual syringe assemblies provide simple and quick dispensing solutions without the need for compressed air. Molded from Polypropylene resin, manual plungers are compatible with a wide range of dispensing fluids. Pistons are made from thermoplastic rubber and are available dry or with lubrication. Sold in packs of 50.

Part No.	Description
7030004PPK	700 Manual Plunger, 3cc
7030002MPK	700 Manual Piston Rubber, 3cc
7030002M-LUBPK	700 Manual Piston Rubber, Lub, 3cc
7050004PPK	700 Manual Plunger, 5cc
7050002MPK	700 Manual Piston Rubber, 5cc
7050002M-LUBPK	700 Manual Piston Rubber, Lub, 5cc
7100004PPK	700 Manual Plunger, 10cc
7100002MPK	700 Manual Piston Rubber, 10cc
7100002M-LUBPK	700 Manual Piston Rubber, Lub, 10cc
7300004PPK	700 Manual Plunger, 30cc
7300002MPK	700 Manual Piston Rubber, 30cc
7300002M-LUBPK	700 Manual Piston Rubber, Lub, 30cc



Rubber Stopper Manual



Plastic Wiper Stopper

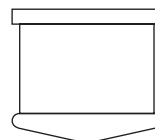

Rubber Stopper Air Powered

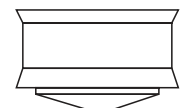

Plastic Wiper Air Powered

400 Series Disposable Dispensing Components

The 400 Series disposable syringes and components are available in a variety of styles to meet a wide range of applications. Sold in bulk packages only.

Syringe Barrels

Barrels are molded from polypropylene. Standard style is Luer lock. Luer slip and taper tip styles are also available, however minimum quantity, lead time and pricing considerations apply. In natural color only (for black and amber refer to page 4).

Stoppers

Rubber stoppers listed are not lubricated. For lubricated stoppers add -LUB to the part number.

Stoppers	
Part No.	Description
403L-2	3cc Rubber Stopper, Manual
406L-2	6cc Rubber Stopper, Manual
435L-2	35cc Rubber Stopper, Manual
403L-7	3cc Plastic Wiper Stopper, Manual
406L-7	6cc Plastic Wiper Stopper, Manual
435L-7	35cc Plastic Wiper Stopper, Manual
403L-2	3cc Rubber Stopper, Air Powered
406L-8	6cc Rubber Stopper, Air Powered
435L-8	35cc Rubber Stopper, Air Powered
403L-9	3cc Plastic Wiper Stopper, Air Powered
406L-9	6cc Plastic Wiper Stopper, Air Powered
435L-9	35cc Plastic Wiper Stopper, Air Powered
460L-9	60cc Plastic Wiper Stopper, Air Powered

Syringe Barrels	
Part No.	Description
F401L-1	400 Syringe Barrel 1cc Luer Slip
403LL-1	400 Syringe Barrel 3cc Luer Lock
406LL-1	400 Syringe Barrel 6cc Luer Lock
435LL-1	400 Syringe Barrel 35cc Luer Lock
460LL-1	400 Syringe Barrel 60cc Luer Lock

Plungers	
Part No.	Description
403L-4	3cc Plunger
406L-4	6cc Plunger
435L-4	35cc Plunger
460L-4	60cc Plunger

400 Series Disposable Dispensing Components

Receiver Head Assemblies

The connecting link between time/pressure controllers and syringe assemblies, Receiver Head Assemblies provide a safe connection between receiver head and syringe barrel for accident proof dispensing. Receiver Head Assemblies come with no tubing (-R), 3 feet of tubing (-3) or 6 feet of tubing (-6).

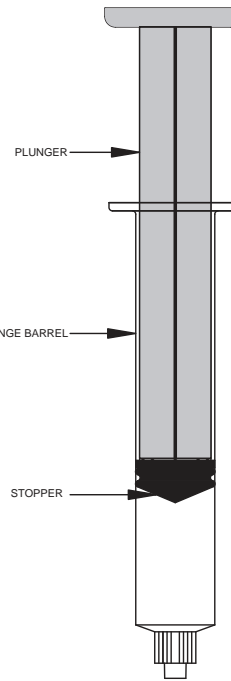

400 Series Receiver Head Assemblies

Part No.	Size
900-250-3L, -6L or -RL	1cc
900-350-3L, -6L or -RL	3cc
900-550-3L, -6L or -RL	6cc
900-650-3L, -6L or -RL	10cc
900-950-3L, -6L or -RL	35cc
900-1150-3L, -6L or -RL	60cc

400 Series Manual Syringe Components

Syringe barrels and plungers are molded from polypropylene; stoppers are molded from polyethylene (-7) or thermoplastic rubber (-2). Plunger locks to the stopper for smooth, controlled manual dispensing. Use of a tip cap will seal the delivery end of the syringe barrel when not dispensing.

Manual Syringes with Rubber Stoppers

Barrels and plungers are molded from polypropylene. Stoppers are molded from thermoplastic rubber.

Size	Syringe	Stopper	Plunger
3cc	403LL-1	403L-2	403L-4
6cc	406LL-1	406L-2	406L-4
35cc	435LL-1	435L-2	435L-4

Manual Syringes with Plastic Stoppers

Barrels and plungers are molded from polypropylene. Stoppers are molded from polyethylene for better chemical compatibility.

Size	Syringe	Stopper	Plunger
3cc	403LL-1	403L-7	403L-4
6cc	406LL-1	406L-7	406L-4
35cc	435LL-1	435L-7	435L-4

Tip Caps

Part No.	Description
15LL	Luer Lock Tip Cap
15LL-B	Black Luer Lock Tip Cap



End Caps

Part No.	Description
TS5	6cc End Cap
TS7	10cc End Cap

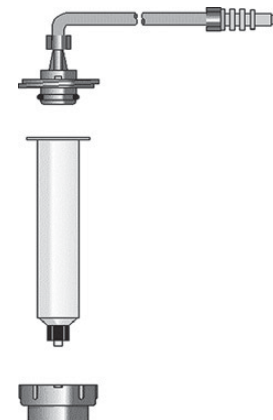

TS Series

Dispensing Tips



TS Series Dispensing Tips

The TS Series Dispensing Tips offer a variety of dispensing performance and flexibility options. Stainless steel tubing is cut to precise lengths and ground to be burr-free. Cut tubing is crimped into aluminum locking insert, then molded into polyethylene hubs. Molded hub colors correspond to gauge size. All TS Series tips secure to Techcon Systems syringe barrels and correspond to the Luer lock specification.

Part Number	International Hub Color	Gauge	I.D. (inches)	I.D. (mm)	Length (inches)	Length (mm)
TS18-1/2-1000	Pink	18	0.033	0.838	0.5	12.7
TS18-1-1000	Pink	18	0.033	0.838	1.0	25.4
TS19-1/2-1000	Brown	19	0.028	0.711	0.5	12.7
TS19-1-1000	Brown	19	0.028	0.711	1.0	25.4
TS20-1/2-1000	Yellow	20	0.024	0.609	0.5	12.7
TS20-1-1000	Yellow	20	0.024	0.609	1.0	25.4
TS21-1/2-1000	Green	21	0.020	0.508	0.5	12.7
TS22-1/2-1000	Black	22	0.016	0.406	0.5	12.7
TS22-1-1000	Black	22	0.016	0.406	1.0	25.4
TS23-1/4-1000	Blue	23	0.013	0.330	0.25	6.35
TS23-1/2-1000	Blue	23	0.013	0.330	0.5	12.7
TS25-1/2-1000	Blue	25	0.010	0.254	0.5	12.7
TS27-1/4-1000	Grey	27	0.008	0.203	0.25	6.35
TS30-1/4-1000	Lavender	30	0.006	0.152	0.25	6.35
TS30-5/16-1000	Lavender	30	0.006	0.152	0.31	7.94
TS30-1/2-1000	Lavender	30	0.006	0.152	0.5	12.7

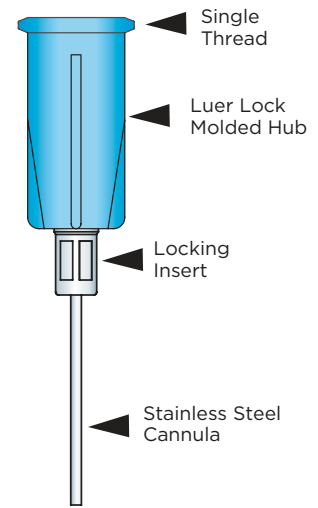

TS-M Metal Dispensing Tips

This series consists of a stainless steel cannula and aluminium hub. Sold in bulk quantity of 500.



Part Number	Gauge	Length (inches)	Length (mm)
TS14-1/2M-500	14	0.5	12.7
TS14-1M-500	14	1.0	25.4
TS14-2M-500	14	2.0	50.8
TS15-1/2M-500	15	0.5	12.7
TS15-1M-500	15	1.0	25.4
TS15-1-1/2M-500	15	1.5	38.1
TS16-1M-500	16	1.0	25.4



TS-SS Metal Dispensing Tips

High precision and tolerance for use in automated applications. With stainless steel cannula and nickel plated brass hub. Length of 1/2" (12.7mm). Sold in packs of 12.

Part Number	Gauge	I.D. (inches)	I.D. (mm)
TS12SS-1/2PK	12	0.087	2.21
TS13SS-1/2PK	13	0.077	1.95
TS14SS-1/2PK	14	0.061	1.54
TS15SS-1/2PK	15	0.056	1.43
TS16SS-1/2PK	16	0.048	1.22
TS17SS-1/2PK	17	0.044	1.11
TS18SS-1/2PK	18	0.033	0.83
TS19SS-1/2PK	19	0.028	0.72
TS20SS-1/2PK	20	0.024	0.62
TS21SS-1/2PK	21	0.021	0.54
TS22SS-1/2PK	22	0.017	0.42
TS23SS-1/2PK	23	0.013	0.34
TS25SS-1/2PK	25	0.011	0.27
TS26SS-1/2PK	26	0.010	0.25
TS27SS-1/2PK	27	0.008	0.21
TS28SS-1/2PK	28	0.007	0.17

MT Series Dispensing Tips

The MT Series precision metal tapered tips deliver the best in high fluid flow rates, which are ideal for high speed dispensing at a fraction of the cost of comparable precision tips in the market. The smooth internal conical fluid flow path increases performance, reduces clogging and back pressure allowing for higher flow rates.

The Phosphor-Bronze metal construction with Electroless Nickel plating makes the MT Series ideal for use in robotic applications or whenever precision counts. The thin walled design at the tip enhances dispensing accuracy while at the same time reduces fluid tailing and stringing. Available from 18 to 30 gauge, the MT Series tips are color coded for easy identification. Sold individually.

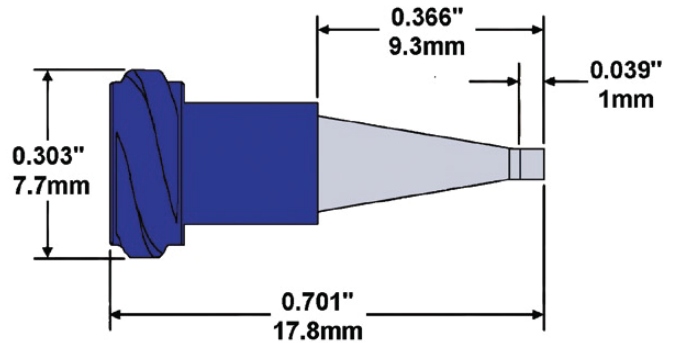

Part Number	Hub Color	Gauge	I.D. (inches)	I.D. (mm)	OD (inches)	OD (mm)
MT18-PBN	Pink	18	0.040	1.019	0.050	1.260
MT19-PBN	Orange	19	0.033	0.839	0.042	1.079
MT20-PBN	Green	20	0.026	0.661	0.035	0.899
MT21-PBN	Blue	21	0.023	0.590	0.033	0.830
MT23-PBN	Purple	23	0.021	0.544	0.026	0.655
MT25-PBN	White	25	0.016	0.417	0.021	0.528
MT27-PBN	Red	27	0.012	0.315	0.017	0.426
MT30-PBN	Black	30	0.008	0.214	0.013	0.325

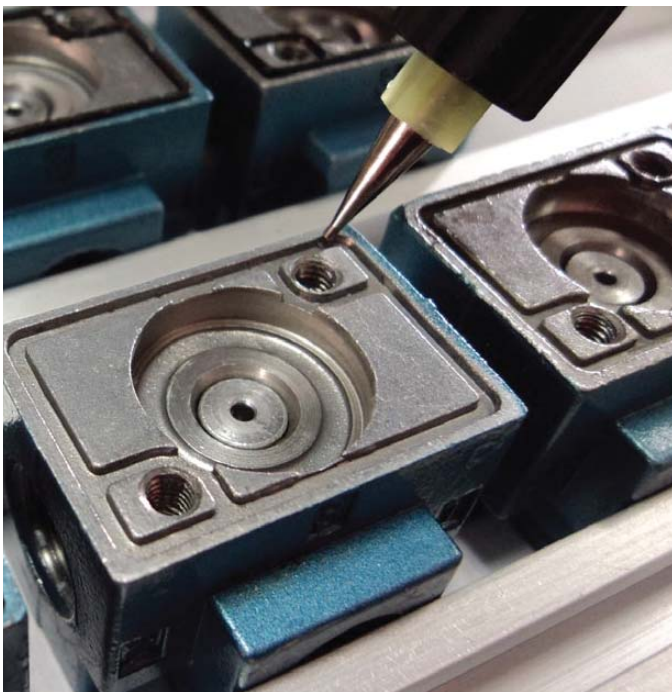

Key Features

- Smooth internal fluid path
 - Reduces turbulent fluid flow
 - Reduces back pressure
 - Increases fluid flow rates
 - Reduces air entrapment and fluid dripping
- Metal construction
 - Provides accurate positioning
 - Ideal for automatic dispensing applications
- Thin walls - Reduces fluid tailing and stringing
- Clog resistant - ideal for filled fluids

TSR2000

Bench-Top Dispensing Robot



TSR2201 - Bench-Top Dispensing Robot

TSR2000 Series Bench-Top Dispensing Robot with Teach Pendant

Techcon bench-top dispensing robots are easy to program, simple to operate and compatible with all valve types and controllers. These versatile dispensing platforms deliver consistent, high performance dispensing results at an affordable price.

Designed and configured specifically for fluid dispensing applications, Techcon robots provide total control over fluid placement, from beads, arcs and circles to repeated timed dots. Programming is simple via teach pendant.

From a general assembly manufacturer looking to automate an existing dispensing application to an engineer designing a production process from scratch, Techcon dispensing robots offers unsurpassed value in automated precision fluid dispensing.

Typical Applications

Dispense dots of solder paste, Form-in-place, gasket, Filling, Potting, Encapsulation, Bonding, Coating

Key Features

- Easy to program and simple to operate
- Programmable interface via teach pendant
- Fast, increase productivity
- Compatible with all Techcon Systems syringes, valves and Jet dispensing systems
- Suitable for wide range of fluid dispensing applications
- Rugged and reliable construction
- Small footprint
- Available in 3 platforms, from 200mm to 400mm

Bench-Top Dispensing Robot Platforms

TSR2201	200mm x 200mm working area
TSR2301	300mm x 300mm working area
TSR2401	400mm x 400mm working area
All systems include Teach Pendant	
Accessories (Light Beam safety cover for each model is available)	
TSR2200-SC	Safety cover for TSR2201
TSR2300-SC	Safety cover for TSR2301
TSR2400-SC	Safety cover for TSR2401

Specifications - Dispensing Robot Series

		TSR2201	TSR2301	TSR2401
Power Supply		100V~240V AC		
Power Consumption		80W		
Number of Controllable Axis		3 axis		
Moving Range	X axis	200mm	300mm	400mm
	Y axis	200mm	300mm	400mm
	Z axis	100mm	100mm	100mm
Speed Range	X/Y axis	0.1~600 mm/sec		
	Z axis	0.1~200 mm/sec		
Repeatability Accuracy	X/Y/Z axis	0.02mm		
Resolution	X/Y/Z axis	0.01mm		
Loading Weight	Base	5 Kg	7 Kg	7 Kg
	Head	4 Kg	4 Kg	4 Kg
Working Ambient	Temperature	0~40°C		
Relative Humidity		20% - 90% (no condensation)		
Dimension (W x D x H)		303 x 377 x 521 mm	418 x 513 x 521 mm	518 x 613 x 521 mm
General Purpose I/O		4 inputs / 4 outputs (Available option: 16 I/O)		

TSR2000 Smart Dispensing Robot

The TSR2000 series smart dispensing robot is designed specifically for precise fluid dispensing applications and it is compatible with all valve types and controllers. The user-friendly smart PC-based software makes the robot easy to program and simple to operate.

Smart features include intuitive software with touch screen programming capability and CAD/DXF file import. The vision system allows the robot to automatically correct part misalignment and shorten programming time via its pattern recognition feature. The laser height sensor allows the robot to automatically adjust Z height to compensate for both surface height changes and part variation.

First choose the Dispensing Robot series from the available 3 platforms:

Bench-Top Dispensing Robot Platforms	
TSR2201	200mm x 200mm working area
TSR2301	300mm x 300mm working area
TSR2401	400mm x 400mm working area

Then choose the Smart features which are available as add-on kits:

Smart Features Add-On Kits	
TSR-STVHKIT	Software, Touch Screen, Vision, Height Sensor Kit
TSR-STVKIT	Software, Touch Screen, Vision, Kit
TSR-STHKIT	Software, Touch Screen, Height Sensor Kit
TSR-SVKIT	Software, Vision, Kit
TSR-SHKIT	Software, Height Sensor Kit
TSR-SKIT	Software Kit

Smart Dispensing Robot Benefits

Simple to program , Quicker learning curve; more visual
Precise and accurate dispensing ; Improved product quality
Increase productivity ; less production line downtime
Plug and play , easy integration into existing production line
Reduced production, material, and ownership costs

Features	Teach Pendant Robot	Robot with Smart Add-On Features
Operating System	Teach Pendant	Smart SBC based Software with Touch Screen Interface
Storage for teaching files	999 files or 60,000 bytes	9,000 files min. or 9.5GB
Storage for processing files	255 files	9,000 files min. or 9.5GB Working Temperature 0 - 40°C
Touch Screen Interface	none	1920 x 1080 (Optimal Resolution)
Camera Type	none	CMOS (2048 x 1536 Resolution, 3.2 Megapixels)
Height Sensor	none	Laser Sensor Resolution: 7Qm; Detection Range: 100 - 335mm



TSR2301 - Smart Dispensing Robot

Key Features

Friendly User Interface

- PC based software
- Touch screen programming
- CAD/DFX conversion

Smart Vision

- CMOS color camera
- Automatic alignment
- Pattern recognition

Laser Height Sensor

- Pinpoint accuracy with integrated laser height sensing
- Detects variations on the surface of a product and automatically adjusts the tip dispensing height
- Prevents uneven deposits and tip or workpiece damage

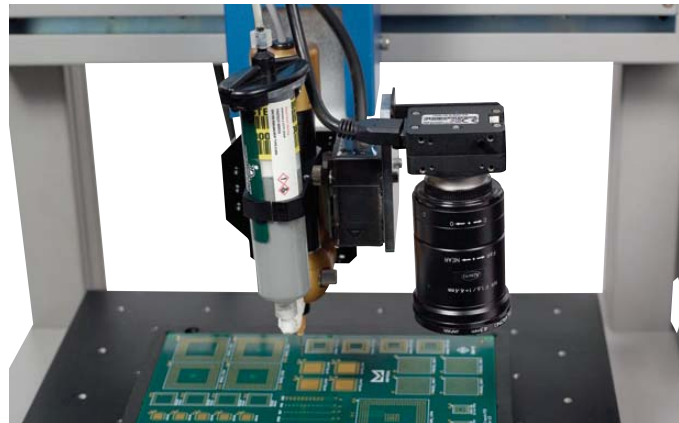

TSR2301 - Smart Robot close-up

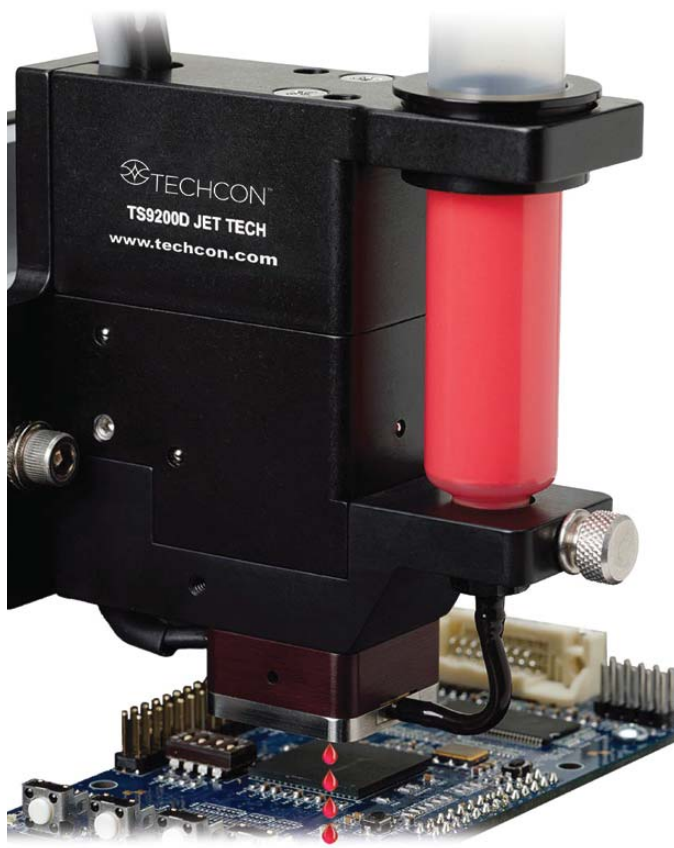

TS9200D - Jet Tech Dispense Valve

Jet Valve System Specifications

Size Width	2.00" (50.8mm)
Size Depth	3.69" (93.8mm)
Size Height	3.50" (88.9mm)
Weight	348g (0.77lb)
Speed	Up to 300Hz Continuous Duty
Syringe Capacity	5, 10, 30 and 55cc
Minimum Shot Size	10nl
Viscosity Range	1 to 400K Cps.
Fluid Pressure	40 psi (2.76bar)
Jet Pressure	35psi to 70psi (2.41 to 4.8bar)
Operating Temperature	10 to 50°C

Key Features

- Non contact Jetting technology
- Accurate and precise dispensing
- High speed, up 300 drops/sec
- Repeatable drop size as small as 10 nl
- Jet fluid up to 400K Cps
- No fluid seals to clean or replace
- Integral heater with minimal fluid heated
- Quick and simple setup
- Low total cost of ownership

TS9200D Series Jet Tech

The TS9200D Jet Tech is a non-contact dispense valve capable of jetting fluid viscosities to 400,000 Cps. Jet Tech offers a fast jetting action producing hundreds of precise droplets in less than one second.

The main feature of the valve is a single, easily replaceable diaphragm to eliminate dynamic fluid seals found in other jet valves. No longer is it necessary to disassemble, clean and replace worn seals, which translates into saving time and money. The diaphragm also allows fast cycle rates because of its very small mass. There is no large sliding valve system that slows down the process. With this novel diaphragm design, the energy needed to eject a drop can be adjusted providing a wider process window.

It's Fast - 300 drops/sec continuous duty. 50% increase in throughput over conventional Jet valves.

It's Simple to Clean - only 2 parts contact the fluid. Conventional Jet valves can have as many as 8 parts requiring cleaning. With only two parts to clean, cleaning the TS9200D takes only minutes and there is no need to remove the Jet valve from the robot. A diaphragm and nozzle plate can be installed immediately without the need to carefully calibrate the Jet valve saving valuable production time and no special off-line cleaner is required.

It's Capable - the TS9200D generates a very high drop velocity allowing a wide range of fluids and applications. In addition, the drop velocity can be easily changed to help fine tune the process and achieve a high process capability and wide process window.

It's Cool - the advanced electronic drive provides power when required and reduces power when idle. The internal air flow cools the Jet body so it runs cool even during high-speed, continuous operation. The integral nozzle heater heats only the fluid in the nozzle plate and is thermally isolated from the jet body.

It's Easy to Integrate - In combination with the standalone TS920 controller, a single trigger line is all that is needed to start dispensing complex programs.

Typical Applications

Jetting silver epoxies for die bonding processes, Jetting silicone phosphor in the LED assembly process, Jetting under-fill in micro-electronic package applications on PCBA, Jetting micro dots of UV adhesive in medical device applications

TS8100 Positive Displacement PC Pump

The TS8100 Series Positive Displacement Pump is a continuously volumetric dispense pump based on Progressive Cavity (PC) technology. The pump is designed to dispense a wide range of fluids, from low viscosity coatings to high viscosity greases.

Techcon's PC Pump uses a special stator and rotor design to provide consistent dispensing output.

The turning rotor moves the fluid in tightly sealed cavities through the stator's fluid chambers to create a volumetric fluid flow that does not change the shape or size of the fluid. Due to the PC Pump's unique dispensing technology, accuracy and repeatability of $\pm 1\%$ is achievable.



Typical Applications

Under filling PCBA components, Encapsulation and Potting applications, Applying lubrication on Automotive parts, Dispensing pastes and flux

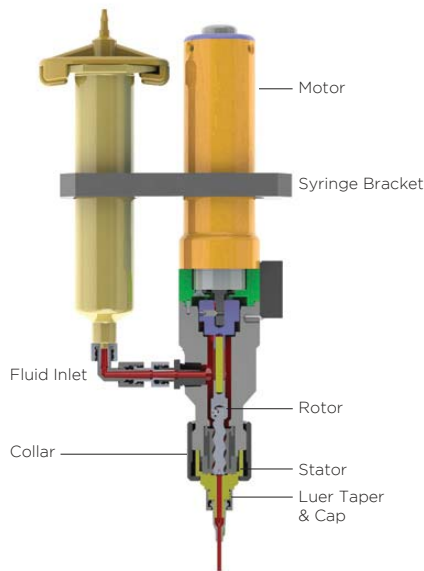

Specifications

Size	8.07" (205mm) L x 1.3" (34mm) W		
Weight	13.4 oz. (380g)		
Wetted Part	Delrin® (Acetal), PFE, Stainless Steel, UHMWPE		
Fluid viscosity	1-300K (Cps or m.Pa.s)		
Precision, absolute (1)	$\pm 1\%$		
Self-sealing (2)	2 bar		
Material inlet port	1/8 NPT		
Material outlet port	Male Luer lock		
Direct mount material reservoir	3 to 55cc		
Part number	TS8100-100	TS8100-200	TS8100-300
Dispense volume per rotation	0.012 ml average	0.047 ml average	0.07 ml average
Flow rate range	0.15 - 1.04 ml/min.	0.47 - 4.46 ml/min.	0.74 - 6.7 ml/min.
Max flow rate recommended (3)	0.65 ml/min.	3.38 ml/min.	5.06 ml/min.
Minimum dispense amount	0.001 ml	0.0045 ml	0.0068 ml

(1) Volumetric dispensing as absolute deviation per complete revolution and also depends on dispensing fluid.

(2) For fluid with viscosity of 1000 Cps or lower. The pump can handle up to 5.5 bar for 300K Cps viscosity fluid.

(3) This is the maximum flow rate that does not shorten the stator work life

Accessories

XYZ Robot: Techcon's Bench-Top Dispensing Robots makes it easy to automate fluid dispensing.

Fluid reservoirs: The pump can be fed from the TS1254 (1.8 litre) or TS1258 (5 litre) Pressure Tank, or from any size syringe barrel or cartridge.

Digital Controller: Techcon's TS580R Digital Controller is designed specifically for the TS8100 PC Pump.

Key Features

- Volumetric, positive displacement
- Accurate and repeatable up to $\pm 1\%$
- No dripping with any viscosity fluid
- Compatible with abrasive materials
- Does not damage or break fillers
- Easy to clean

TS5000DMP-DCX

Rotary Microvalve



TS5000DMP - Performing underfill

Specifications - TS5000DMP-DCX

Size (Imperial)	1.56" W x 3.56" L x 5.88" H
Size (Metric)	39.6mm x 90.4mm x 149.4mm
Weight	0.73 lb. (331 g)
Fluid Inlet	Luer Lock female
Fluid outlet	Luer Lock male
Door Opening	Right hand side
Input Voltage	5 - 24 VDC
Fluid Pressure	30 psi (2.07 bar) MAX
Cycle Rate	300 cycles/min.
Mounting Port	1.0" (25.4mm) Channel
Viscosity Range	30K - 1300K cps
Wetted Parts	Delrin®, Viton®, Nylon

DMP Valve options

	Disposable Path Material	Rotating Luer Collars
6 Pitch	DMP6-10	DMP6R-10
8 Pitch	DMP8-10	DMP8R-10
16 Pitch	DMP16-10	DMP16R-10

Key Features

- Precise and consistent shot sizes
- Motor reverse capability
- Field replaceable wetted parts
- Adjustable dispense rate
- Closed-loop motor control with encoder feedback (encoder version)

TS5000DMP-DCX

Rotary Microvalve

Techcon's patented Disposable Material Path (DMP) valve contains a disposable feed screw for easy maintenance and reliable dispensing.

With the feed screw made of Delrin®, the valve is designed for use with two-compound and UV fluids. The DMP valve has a hinged doorway that opens easily so the disposable feed path can be removed, disposed of and replaced within seconds while the line is still in operation. No cleaning or refurbishment of the valve is required.

The DMP-DCX is the perfect valve for applications where removing the valve, for cleaning, is inconvenient and costly. With the ability to remove and replace the disposable material path, the valve maintains its accuracy over a greater period of time. With less fluid build up to reduce wear-and-tear on the motor, the valve's usable lifetime is dramatically increased.

The TS5000DMP-DCX Series valve offers three options in feed screw pitch type: 6, 8 and 16 pitch - all DMP inserts are made available with a fixed or rotating color coded tip collar.

Typical Applications

Solder paste, die attach, surface mount adhesive, chip encapsulation, dam writing, two-part epoxy, UV adhesive.



Optional encoder motors are available for closed loop feed back requirement.



TS5000DMP - Right hand opening. Left and front door opening also available.



TS5000 - Disposable path available in 3 different pitches, and with 3 different rotating Luer collars.

TS7000-DCX Series Interchangeable Material Path (IMP) Rotary Valve

The TS7000-DCX Series IMP Rotary Valves uses a feed screw to dispense fluid with a rotary displacement action, allowing ultra-precise control of the dispensing process.

The valve's modular design allows quick and easy replacement of the feed screw/chamber (cartridge assembly) without removing the valve from the machine. In addition, the valve cartridge assembly can be interchanged to be used with TS-5000DMP feed screw inserts - The 7000-DMPBKIT retrofit kit is required.

The TS7000-DCX Series valve is available in 4 choices of feed screw sizes (8-pitch, high output 8-pitch, 16-pitch and 32-pitch), all made of precision hardened tool steel. An encoder motor version is available for applications that require closed-loop motor control with encoder feedback.

Typical Applications

Solder Paste, Die Attach, Surface Mount Adhesive (SMA), Chip Encapsulation, Dam Writing, Thermal Grease.

Recommended Controller
TS570R Digital Controller

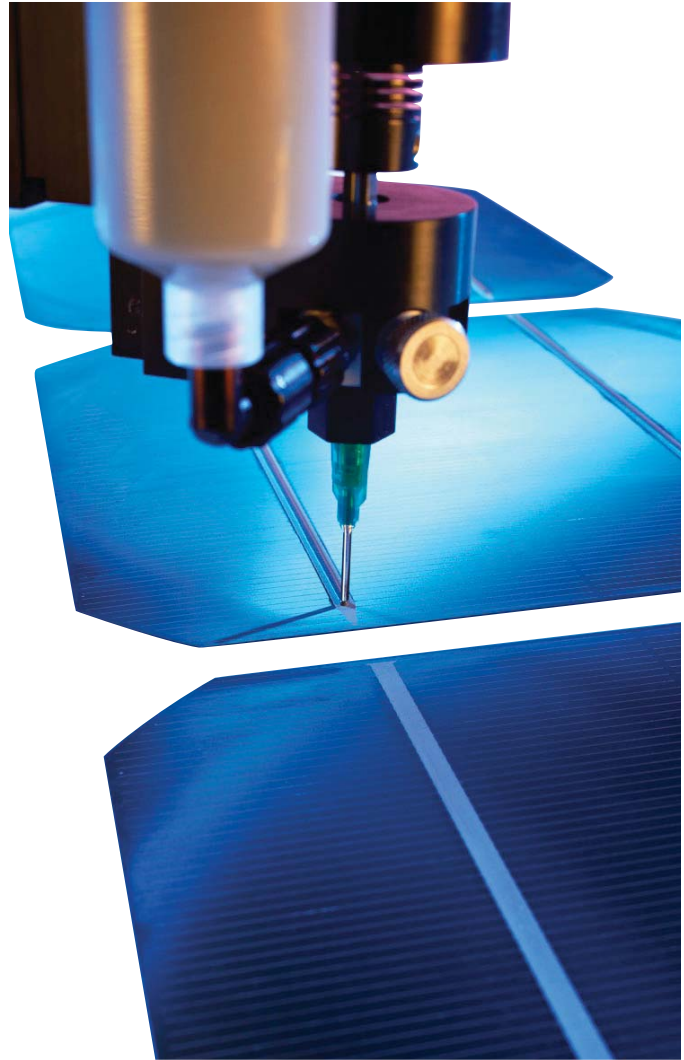

TS7000-DCX - Solar cell tabbing

Specifications - TS7000-DCX

Size (Imperial)	6.78" x 3.70" x 2.23"
Size (Metric)	172.2mm x 94mm x 56.6mm
Weight	0.96 lb. (438g)
Fluid Inlet Port	Luer lock female
Fluid Outlet Port	Luer taper and cap
Input Voltage Range	4 - 24VDC
Max Fluid Pressure	30 psi (2.07bar)
Operating Frequency	300+ cycles/min.
Mounting Port	1"/25.4mm channel
Viscosity Range	30K - 1 300Kcps
Wetted Parts	303SS, UHMWPE, Nylon®

Cartridge Assembly

Part Number	Description
7090-9140	Cartridge Assembly, 32-Pitch
7090-9040	Cartridge Assembly, 16-Pitch
7090-9030	Cartridge Assembly, 8-Pitch
7090-9050	Cartridge Assembly, 8-Pitch HO

Valves

Part Number	Description
TS7000-DCX-8	Rotary Valve, 8P Feed Screw
TS7000-DCX-8HO	Rotary Valve, 8P High Output Feed Screw
TS7000-DCX-16	Rotary Valve, 16P Feed Screw
TS7000-DCX-32	Rotary Valve, 32P Feed Screw
TS7000E-8-DCX	Rotary Valve, 8P Feed Screw
TS7000E-8HO-DCX	Rotary Valve, 8P High Output Feed Screw
TS7000E-16-DCX	Rotary Valve, 16P Feed Screw
TS7000E-32-DCX	Rotary Valve, 32P Feed Screw

Key Features

- Accurate and repeatable dispensing output
- Field replaceable spare parts
- Quick and easy feed screw/chamber cartridge changeover
- Closed-loop motor control with encoder feedback (encoder version)

TS5620

Diaphragm Valves

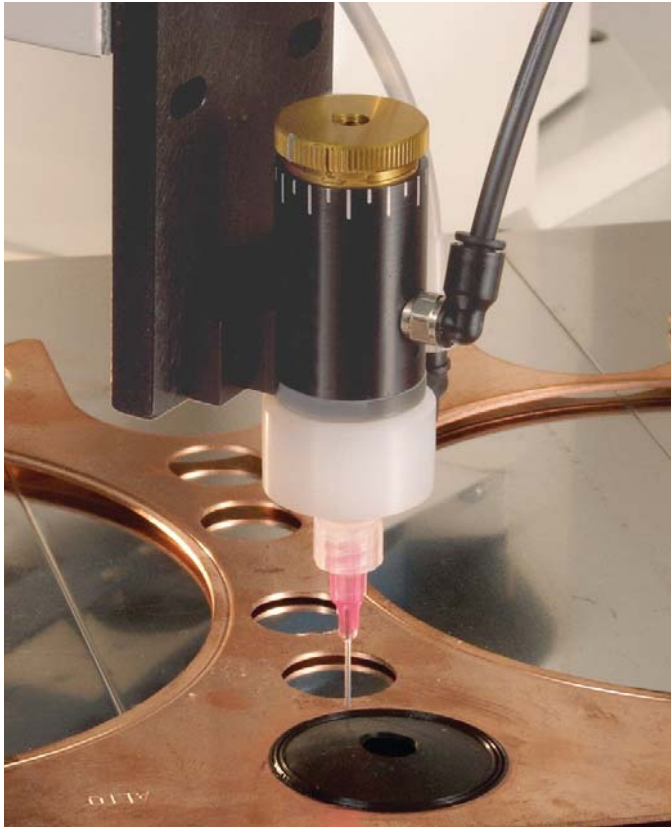

TS5622 - Dispensing cyanoacrylate

TS5620 Series Diaphragm Valves

Diaphragm Valves are designed to dispense low to medium viscosity materials with precision accuracy over a wide range of shot and bead sizes down to a fraction of a micro liter. A short opening stroke provides fast, positive shut-off. An external stroke control adjustment makes it easy to fine-tune shot sizes. The compact design allows for mounting flexibility and easy integration into automated applications.

Body available in FDA-compliant Ultra High Molecular Weight Polyethylene (UHMWPE) for most applications. A Teflon® version for chemical compatibility and a Delrin® version for UV-curable are also available. A stainless steel version with optimized internal fluid route is especially dedicated to dispense UV-cure adhesives, resins and lacquers used in the manufacture of DVDs and CDs. A hand-held actuated valve is also available. The valves are easy to use and maintain with user replaceable spare parts.

Typical Applications

To dispense a wide range of shot sizes of low viscosity fluids such as: cyanoacrylates, anaerobics, liquid fluxes, solvents, UV-cure adhesives, resins and lacquers



TS5622VT

TS5622VU-DVD



Key Features

- Excellent moisture sensitive resistance
- Adjustable stroke control
- Compact size and weight
- Simple and low maintenance design
- Long life cycles

Specifications

Length	2.4" (61mm) - 3.47" (88mm) (Depending on exact configuration)
Diameter	0.94" (24mm) - 1.06" (27mm)
Weight	0.13 lb. (59 g) to 0.26 lb. (118 g)
Wetted Parts	Depending on exact configuration
Viscosity Range	1-50k cps
Max Fluid Pressure	70 psi (4.8 bar)
Activation Pressure	70 psi (4.8 bar) - 90 psi (6.2 bar)
Connections	Depending on exact configuration
Mounting	10-32 UNF (not available on handheld models)

Part Number	Description
TS5620HU	Horizontal valve UHMWPE
TS5621HD	Horizontal valve Delrin®
TS5620HT	Horizontal valve Teflon®
TS5622VU	Vertical Valve UHMWPE
TS5622VD	Vertical Valve Delrin®
TS5622VT	Vertical Valve Teflon®
TS5622VU-DVD	Vertical Valve, UHMWPE and Stainless Steel
TS5623HU	Hand Held Valve UHMWPE
TS5623HD	Hand Held Valve Delrin®
TS5623HT	Hand Held Valve Teflon®

TS5624DMP Disposable Material Path Diaphragm Valve

The TS5624 Disposable Diaphragm Valve features a “first to market” Disposable Material Path. Difficult fluids such as CA’s and pre-mixed 2-part epoxies, can now be dispensed without the need of frequent cleaning by simply replacing the entire wetted area in a matter of seconds, while the valve stays on the production line.

The wetted parts are manufactured from black polyethylene to prevent moisture and UV light come into contact with the dispense fluids. As a result, moisture sensitive fluids such as cyanoacrylate and UV cured adhesives can be dispensed reliably and accurately.

The TS5624 dispenses low to medium viscosity fluids over a wide range of shot and bead sizes, down to a fraction of a micro liter. An internal spring return makes the valves fully adaptable for use with Techcon Systems controllers. A short opening stroke provides an extremely fast and positive shut-off.

The seal-less valve design offers an excellent moisture sensitive resistance and the incorporated diaphragm creates a barrier between the wetted parts and the air cylinder.

Typical Applications

Dispensing pre-mixed 2-part epoxy, dispensing cyanoacrylate in bonding applications, applying a of UV lacquer in CD/DVD spin coating, applications

Specifications	
Part Number	TS5624DMP
Length	3.34" (84.8mm)
Width	2.15" (54.6mm)
Weight:	0.25 lb. (113g)
Fluid Inlet Port	Luer lock female
Fluid Outlet Port	Luer lock male
Aux Air Inlet Port:	10-32 UNF female
Activation Pressure Range	70 psi - 90 psi, (4.8bar - 6.2bar)
Max Fluid Pressure	60 psi (4.1bar)
Operating Frequency	400+ cycles/min.
Mounting Port	10-32 UNF female
Viscosity Range	1 - 50 000cps
Wetted Parts	Black Polyethylene Compound
Accessories	
Replacement DMP Insert	DMP-5624
Syringe Bracket	7509-9100 fits all syringe sizes
Fluid Reservoirs	The valve can be fed from the TS1254 or TS1258 Pressure Tank, or from any size syringe or cartridge.
Dispense Tip	For complete dispense tip selection please see page 6.



TS5624DMP - Disposable Material Path Diaphragm Valve



Key Features

- Disposable material path - no cleaning
- Compact size and weight
- Excellent moisture sensitive resistance
- No special tools required
- Low cost of ownership
- Accurate and repeatable dispensing

TS5400

Needle Valves



TS5440 - Dispensing medical device adhesive

TS5400 Series Needle Valves

Needle Valves dispense very precise deposits over a wide range of shot and bead sizes due to a minimal dead fluid zone. An external stroke control adjustment to fine-tune shot sizes. Easy to maintain, with little or no downtime. The compact design and easy-mount threaded hole allows for easy integration into automated applications.

The TS5420 Adjustable Needle Valve is a pneumatically triggered single-acting valve that can be used with an integral spring close (single action) or may be connected for air closing without the spring (double acting).

The TS5440 Microshot Needle Valve, with its needle closing the fluid path directly on the cannula inside the dispensing tip hub, can dispense very precise deposits down to 0.0005 cm³.

Typical Applications

To dispense microdots of low viscosity fluids such as: solvents, inks, oils, activators, primers; the TS5440 is excellent to dispense microdots of UV adhesive used in medical device manufacturing.

Valves			
Part Number	TS5420	TS5420SS	TS5440
Size and Weight	L: 4.4" (112mm) D: 1.12" (28mm) Weight: 0.3 lb. (136 g)	L: 4.4" (112mm) D: 1.12" (28mm) Weight: 0.5 lb. (227 g)	L: 5.0" (127mm) D: 1.12" (28mm) Weight: 0.5 lb. (227 g)
Wetted Parts	303 SS, Anodized Al, Teflon®, EPR, Delrin®	303 SS, Teflon®, EPR, Delrin®	303 SS, Teflon®, EPR
Maximum Fluid Pressure	300 psi (20.7 bar)	300 psi (20.7 bar)	100 psi (6.9 bar)
Activation Pressure	70 psi (4.8 bar) Minimum	70 psi (4.8 bar) Minimum	70 psi (4.8 bar) Minimum
Connections	Inlet: 1/8" NPT Outlet: Male Luer Lock	Inlet: 1/8" NPT Outlet: Male Luer Lock	Inlet: 1/8" NPT Outlet: Taper w/ Luer Lock
Mounting	1/4"-20UNC-2B	1/4"-20UNC-2B	10-32 UNF
Recommended Viscosity Range	1-100k cps	1-100k cps	1-100k cps



TS5420
Needle Valve



TS5440
Microshot
Needle Valve

Key Features

- Precise and consistent shot sizes
- Adjustable flow control
- Zero dead fluid zone
- Simple and low maintenance design



TS941 High Pressure Spool Valve

The Spool Valves provide precise shot accuracy along with “high volume” capacity over a range of material viscosities, shot sizes and pressures. They feature “suck back” anti-drip as well as a fast on/off dispensing function that is not affected by material input pressure. An optional oil chamber creates an additional liquid seal to prevent moisture from being carried on the spool, excellent for moisture sensitive materials. Pneumatically activated, the valves can be used with an internal spring close (single acting) or an air-closing connection (double acting).

Output is a 1/4" NPT which allows multiple tip types to be used.

TS5322 Mini Spool Valve

The Mini Spool Valve Series is designed for better accuracy with lower pressure. The series operates similar to the TS941, however, it is smaller in size.

Typical Applications

Suitable for moisture sensitive adhesive when utilizing supplied oiler. The Spool Valves can be used in a wide range of applications such as flux paste, grease, RTV Silicone, UV cure gel, solder mask, gasketing.



TS941 - Gasketing

Valve Specifications

Part Number	TS941	TS5322
Length	4.7" (119mm)	4.00" (101.6mm)
Diameter	1.5" (38mm)	1" (25mm)
Weight	1.61 lb. (726 g)	0.31 lb. (141 g)
Wetted Parts	303 Stainless Steel, UHMWPE, EPR	303 Stainless Steel, Anodized Al, Teflon®, EPR
Viscosity Range	5 - 3000k cps	5 - 1000k cps
Max Fluid Pressure	2500 psi (172.4 bar)	500 psi (34.5 bar)
Activation Pressure	70 psi (4.8 bar)	70 psi (4.8 bar)
Material Inlet	3/8" NPT	1/8" NPT
Material Outlet	1/4" NPT	1/8" NPT
Mounting	1.50" Diameter	1/4"-20UNC-2B

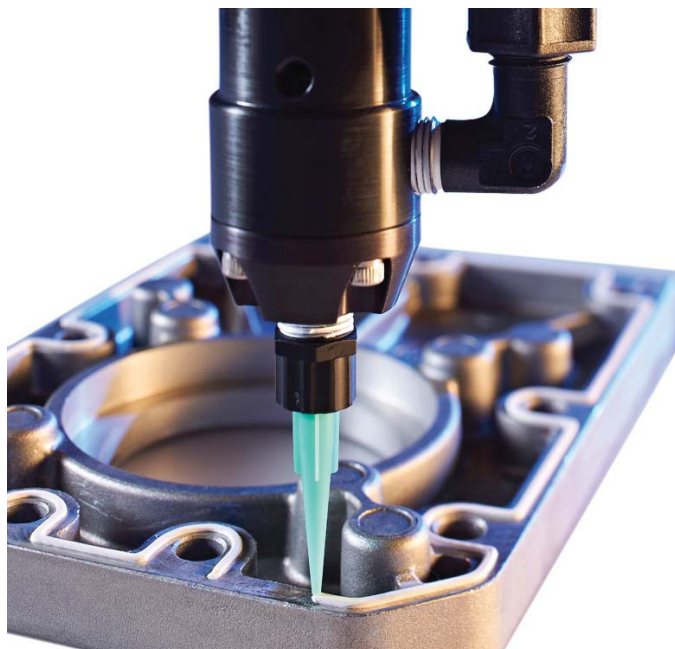

TS5322 - Gasketing



TS5322
Mini Spool Valve



TS941
Spool Valve

TS1212/1201

Pinch Tube Valves



TS1201 - Dispense pen

Specifications

Part Number	TS1201	TS1212
Length	5" (127mm)	2.49" (63mm)
Diameter	1.34" (34mm)	1.58" (40mm)
Weight	0.08 lb. (36 g)	0.18 lb. (82 g)
Wetted Part:	Polyethylene (standard), Polyurethane (optional)	
Viscosity Range	1-45k cps	
Max Fluid Pressure	60 psi (4.1 bar)	
Material Inlet	Female Luer Lock	
Material Outlet	Male Luer Lock	
Mounting		1/4"-20UNC-2B
Activation Pressure		50 psi (3.4 bar) minimum



TS1212 - Pneumatic Pinch Tube Valve

Key Features

- Disposable fluid path
- Simple to operate
- Compact size and weight

TS1212/1201

Pinch Tube Valves

TS1201 Dispense Pen

The TS1201 Dispensing Pen uses a disposable moulded tube assembly. Designed to handle a wide variety of fluids - from adhesives and lubricants to sealants and masks. Gravity or pressure fed, the pen has a built-in shot and flow rate for repeatability. Includes pre-assembled applicator pen, two clear and two black spare pinch tube assemblies, an assortment of disposable dispensing tips and a 24" (0.61m) hose. Replacement pinch tube assemblies sold in packs of 10.

TS1212 Pneumatic Pinch Tube Valve

Provides control for continuous or micro shot applications of low to semi-viscous fluids. The "ON/OFF" control is achieved by automatically opening and closing (pinching) a moulded polyethylene tube assembly. Adjusting the opening size of the pinch tube assembly determines the shot size or flow rate. In addition, the air actuated valve can be timed to develop desired shot sizes. Finally, a wide range of dispensing tips can be used to further refine the amount of dispensed output. The only part of the valve making contact with the fluid being dispensed is the disposable pinch tube assembly. Replacement pinch tube assemblies are sold in packages of 10.



Typical Applications

Cyanoacrylates, anaerobics, two-part adhesive, etc.



Spare Pinch Tube for TS1201 (Sold in packs of 10)

Part Number	Material	I.D.	Connection
1201-000-004BPK	Black PE	0.1" (2.54mm)	Male to Female
1201-000-004PK	Natural PE	0.1" (2.54mm)	Male to Female
1201-000-006PK	Natural PE	0.07" (1.78mm)	Male to Female
1201-006-000PK	Natural PU	0.125" (3.18mm)	Male to Female

Spare Pinch Tube for TS1212 (Sold in packs of 10)

Part Number	Material	I.D.	Connection
1212-004-002BPK	Black PE	0.1" (2.54mm)	Male to Female
1212-004-002PK	Natural PE	0.1" (2.54mm)	Male to Female
1212-004-000PK	Natural PE	0.07" (1.78mm)	Male to Female
1212-004-100BPK	Black PU	0.125" (3.18mm)	Male to Female
1212-004-100PK	Natural PU	0.125" (3.18mm)	Male to Female

TS5500 Series Spray Valves

The Spray Valves are designed for precise spray applications of low viscosity materials. Total control of the spray cycle is provided by adjustable fluid flow and precise control of pre-spray, atomizing air and post-spray with the TS560R Valve Controller. Normal maintenance is simple and downtime is virtually eliminated with only one seal to replace.

The TS5540 Spray Valves come with FDA-Compliant 303 stainless steel construction in both air cylinder and fluid housing. A field replaceable Delrin® seat provides positive shut-off and extends life cycles. The compact design and easy-mount threaded hole allow for easy integration into automated applications.



Typical Applications

To spray fine mist of low viscosity fluids such as: conformal coating, solvent, oil, etc.

Valve Specifications

	TS5520	TS5540
Length	4.2" (107mm)	4.2" (107mm)
Diameter	1.12" (28mm)	1.12" (28mm)
Weight	0.3 lb. (136 g)	0.74 lb. (336 g)
Wetted Parts	303 SS, Teflon®, EPR, Anodized Al, Delrin®	303 SS, Teflon®, Delrin®
Viscosity Range	1-1k cps	1-5k cps
Max Fluid Pressure	100 psi (6.9 bar)	
Activation Pressure	70 psi (4.8 bar) Minimum	
Connections	Inlet: 1/8" NPT Outlet: Spray nozzle	
Mounting	1/4" 20UNC-2B	



TS5540
Spray Valve
with Cone Nozzle



Cone Nozzle



TS5540
Spray Valve
with Fan Nozzle



Fan Nozzle



TS5520
Spray Valve
with Cone Nozzle



TS5540-MS
Microshot
Spray Valve

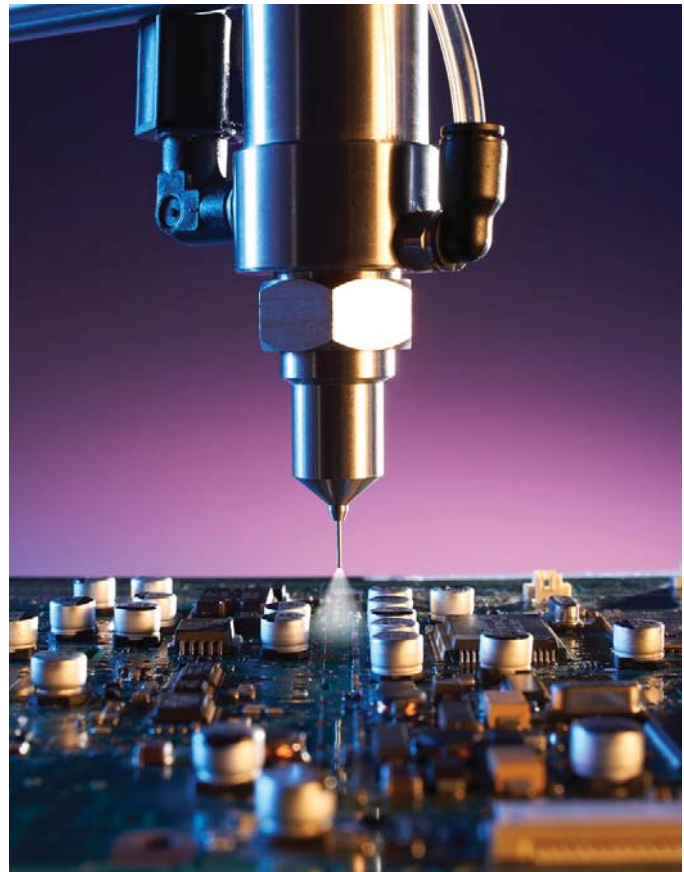

TS5540-MS - Spraying conformal coating

Valves with Nozzles

	Opening Diameter	Cone Nozzle	Fan Nozzle
TS5520	0.046" (1.17mm)	Standard	Not available
TS5540	0.014" (0.356mm)	TS5540-014R	TS5540-014F
	0.028" (0.711mm)	TS5540-028R	TS5540-028F
	0.046" (1.17mm)	TS5540-046R	TS5540-046F

Nozzles Only

	Opening Diameter	Cone Nozzle	Fan Nozzle
	0.014" (0.356mm)	RNC014	FNC014
	0.028" (0.711mm)	RNC028	FNC028
	0.046" (1.17mm)	RNC046	FNC046

TS5540-MS Microshot Spray Valve

The TS5540-MS spray valve is designed to spray low viscosity materials through disposable dispensing tips. Spray patterns range from 0.18" - 0.60" (4.6mm-15mm) in diameter.

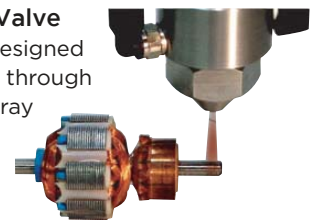

Key Features

- Consistent spray coverage with no overspray
- Positive shut-off
- Adjustable flow control
- Long life cycles

TS500 Series

Smart Valve Controllers



TS580R - PC Pump Controller

Specifications

Parameters	Part Number	Description
	TS550R	Smart Pneumatic Valve Controller
	TS560R	Smart Spray Valve Controller
	TS570R	Smart Auger Valve Controller
	TS580R	Smart PC Pump Controller
Size (Imperial)	11.4" W x 8.3" L x 3.9" H	
Size (Metric)	290mm x 211mm x 99mm	
Weight	6.8 lb. (3100g)	
Pressure Range	0 to 100psi (0-6.9 bar)	
Display	Touch Screen	
Timing Range	0.008 - 99.9 seconds	
Timing Tolerance	+/- 0.001%	
Input Voltage	100 - 240 VAC	
Cycle Rate	900/min.	
Cycle Modes	Timed, Interrupt, Teach, Purge	
Connectivity	Ethernet, WiFi	
Certification	CE, TUV-GS	

Accessories

Fluid reservoirs	The controller can be used in combination with the TS1254 or TS1258 Pressure Tank (See page 26)
Dispensing Tips	Suitable for use with all tip series. (See page 6)



TS570R - Set-Up Screen



TS500 Series Smart Valve Controllers

We are pleased to introduce our new series of smart valve controllers: the **TS550R**, **TS560R**, **TS570R** and **TS580R** that will control our complete line of precision valves. Equipped with a universal power supply, the new smart valve controllers are fully “plug-and-play” and can be used immediately anywhere in the world.

All of our smart valve controllers feature an intuitive touch-screen interface for easy setup and operation. Dispensing parameters can be precisely configured directly on the touch screen or remotely through the networking options.

First in their class, the smart valve controllers are equipped with Ethernet and WiFi interfaces to allow users to configure the exact parameters and monitor and control the process from anywhere in the world. This feature complies with Smart Factory requirements on Industry 4.0.

Additional advance features include digital timer to provide accurate and repeatable spray time, and a digital pressure regulator with dual-unit display to allow precise pressure control. The friendly user interface provides an option to program up to 50 varied, sequenced or individual shots. These systems have a user programmable “purge,” “timed” dispense cycle settings and a “teach mode” for determining the dispensing time.

Integration into semi-automatic and automatic machinery is made easy with the I/O interface connector that can be used to initiate and stop the dispense cycle with feedback to the host machine for the next cycle. A low-pressure warning feature is also included to help maintain uninterrupted dispensing.

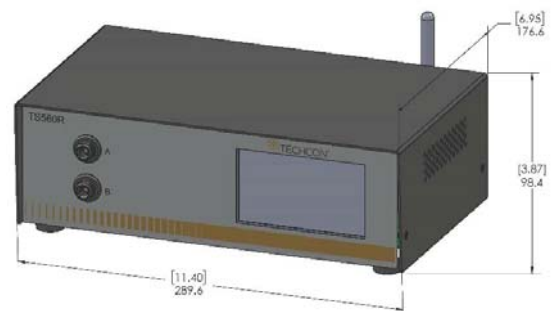
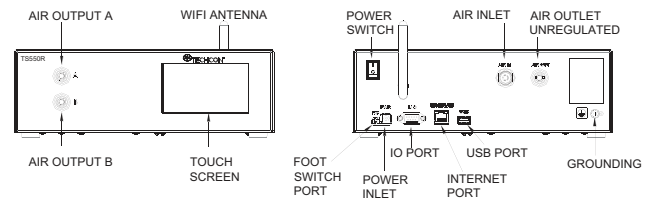

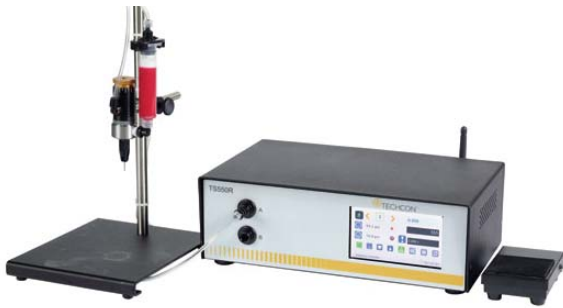

The **TS550R** Smart Valve Controller is capable of controlling all Techcon pneumatic valve series including: TS1212 Pinch Tube Valve, TS941/TS5322 Spool Valve, TS5420/TS5440 Needle Valves and TS5620/TS5622 Diaphragm Valves.



The **TS570R** Smart Auger Valve Controller is capable of controlling all Techcon TS5000 and TS7000 Auger Valves.



Typical Applications

Control diaphragm valve for bonding application, control mini-spool valve for form-in-place gasket, and control needle valve for precision filling process.

Part Number	Description
TS550R	Smart Pneumatic Valve Controller



The **TS560R** Smart Spray Valve Controller is capable of controlling all Techcon TS5520 and TS5540 Spray Valves.



Typical Applications

Conformal coating, lubrication and marking application.

Part Number	Description
TS560R	Smart Spray Valve Controller



Typical Applications

Solder paste dispensing, encapsulation and potting applications.

Part Number	Description
TS570R	Smart Auger Valve Controller



The **TS580R** Smart PC Pump Controller is capable of controlling all Techcon TS8100 series PC Pumps.



Typical Applications

Underfilling PCBA components, encapsulation and potting applications, applying lubrication on automotive parts, and dispensing pastes and flux.

Part Number	Description
TS580R	Smart PC Pump Controller

Smart Valve Controllers - Key Features

- Touch Screen interface for easy setup and operation
- Industry 4.0 for "Smart Factory" integration
- Universal power supply for worldwide use
- Digital pressure regulator for precise control
- Digital timing control for repeatable output

TS1254/1258

Pressure Pot



TS1258 - Pressure pot

Specifications - Pressure Pot

	TS1258
Size	10" x 15.1" (254 x 383mm)
Chamber	6.1" I.D. x 11.0" (155 I.D. x 280mm)
Weight	21 lb. (9.5 kg)
Max Operating Pressure	100 psi (6.9 bar)
Internal Volume	5 liters
	TS1254
Size	7.5" x 12.5" (190 x 318mm)
Chamber	4.75" I.D. x 6.5" (121 I.D. x 165mm)
Weight	10.4 lb. (4.7 kg)
Max Operating Pressure	70 psi (4.8 bar)
Internal Volume	1.8 liters

TS1254/1258

Pressure Pot

The Pressure Pot is designed to accommodate low to medium viscosity fluid including solvents, adhesives, as well as CAs and UVs. The fluid feed line is located in the center of the unit for a direct and continuous feed path from the reservoir to the dispensing valve. The TS1258 is shipped with a 1/4" tubing and the TS1254 is shipped with a 6mm tubing. For use with the TS1212 or TS1201 valve, a TS1252-4MM Fluid Line kit is needed.

TS918

Four-way Manifold

Designed to provide equal flow for up to four fluid paths, the TS918-46 is used whenever precision fluid flow to multiple stations is required. The Manifold works with the TS1258 Pressure Pot (TS1258-375 Hose Kit required to use TS918-46 and TS1258 together). Made from Delrin® and suitable with UV materials. The manifold can be used with any Techcon Systems Valve.

Specifications - TS918-46 Four-way Manifold

Size	2.6" x 2.2" (66 x 56mm)
Inlet Port	1/4" NPT (3/8" O.D. tube fitting is included)
Outlet Port	1/8" NPT (4 Luer Lock fittings are included)
Max Operating Pressure	100 psi (6.9 bar)
Mounting	1/4"-20UNC-2B (x2)

Available Fluid Line Kits (Includes clear and black tubing)

For the TS1258 Pressure Pot	
TS1252-4MM	4mm O.D. tube (required for TS1212 and TS1201 connection)
TS1258-250	1/4" O.D. tube
TS1258-375	3/8" O.D. tube
For the TS1254 Pressure Pot	
TS1252-4MM	4mm O.D. tube (required for TS1212 and TS1201 connection)
254-250PE	6mm O.D. tube PE

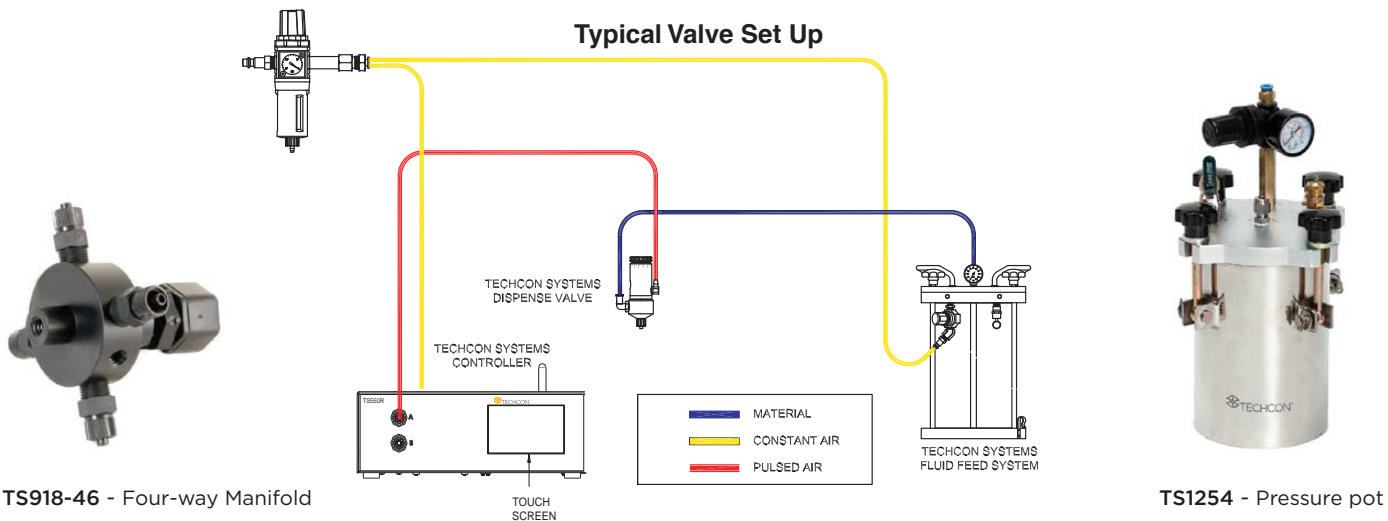

Fluid Dispensing Valves

Fluid Dispensing Valves

Techcon Systems offers a wide range of fluid dispensing valves from simple manual dispensing to precision valves for high speed automated applications. The range of valves includes:

- Disposable material path valves for use with difficult materials.
- Easily maintained precision shot valves with excellent accuracy over a wide range of viscosities, material pressures and shot sizes.
- High speed valves for the precise deposit of heavy viscosity filled pastes and highly abrasive materials.

Techcon Systems offers a wide array of valve choices to meet every fluid dispensing need. Users are encouraged to utilize the “Techcon Material Test Program” to help define the appropriate valve for standard and unique applications. See our web site or contact Techcon Systems to access this unique and complimentary service. The following charts display the variety of valve features available.

Recommended = ●

Valve Type	Viscosity Range			Small shot Accuracy by Viscosity Range			Disposable Material Path	Field Replaceable wetted parts	High Flow Rate	High Feed Pressure	Aggressive Material	Abrasive Material	Atomizing Spray
	Low	Med	High	Low	Med	High							
TS1201	●						●	●			●		
TS1212	●						●	●			●		
TS941		●	●					●	●	●	●		
TS5322		●	●		●	●		●		●			
TS5420	●			●				●			●		
TS5440	●	●		●	●			●			●		
TS5540/5520	●							●			●		●
TS5622	●			●				●			●		
TS5624DMP	●			●			●	●			●		
TS5000DMP		●	●		●	●	●	●				●	
TS7000		●	●		●	●		●			●	●	
TS8100	●	●	●	●	●	●		●			●	●	
TS9000/9200	●	●	●	●	●	●		●			●	●	

Viscosity Rating; Low = Up to 30K Cps; Med = 30K-100K Cps; High = 100K Cps - up

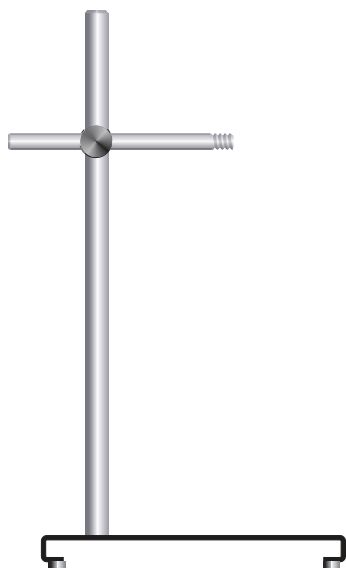

Production Master Systems

Production Master Systems provide added flexibility and productivity for hands-free, remotely controlled dispensing. It incorporates a unique “building block” concept to provide more versatility in specific dispensing applications. The system consists of a basic production master stand, mounting rod, brackets and a rod clamp.

Part Number	Description
918-033-000	Production Master Stand (Base and Support)
918-000-011	Syringe Bracket for 400 Series
918-000-013	TS934/TS941 Spool Valve Bracket
918-110-004	1/10 gallon (325ml) Cartridge Bracket
918-000-007	2.5 oz. (74ml), 6 oz. (177ml), 8 oz. (237ml) and 12 oz. (355ml) Cartridge Bracket
918-000-039	20 oz. (591ml) Cartridge Bracket
918-000-012	Rod Clamp Assembly
918-000-009	6” Non-Threaded Mounting Rod
1212-000-008	6” 1/4-20UNC-2B Threaded Mounting Rod
5620-000-008	4” 10-32 Threaded Mounting Rod
5000-000-005	TS5000DMP/TS7000IMP Mounting Bracket

Dispensing Accessories

Fluid Line Assemblies

Each polyethylene hose assembly is provided with a moulded Luer lock fitting on one or both ends. The assembly can be used with other standard Luer lock connectors and will handle up to 100 psi (6.9 bar) working pressure.

Fluid Line Assemblies			
Part Number	Size	Connection	Material
TSD126-118PK	0.100" (2.54mm) x 18" (457mm)	Male Luer/open	Natural PE
TSD126-124PK	0.100" (2.54mm) x 24" (610mm)	Male Luer/open	Natural PE
TSD126-136PK	0.100" (2.54mm) x 36" (914mm)	Male Luer/open	Natural PE
TSD126-218PK	0.100" (2.54mm) x 18" (457mm)	Female Luer/open	Natural PE
TSD126-224PK	0.100" (2.54mm) x 24" (610mm)	Female Luer/open	Natural PE
TSD126-236PK	0.100" (2.54mm) x 36" (914mm)	Female Luer/open	Natural PE
TSD126-318PK	0.100" (2.54mm) x 18" (457mm)	Male Luer/female Luer	Natural PE
TSD126-318BPK	0.100" (2.54mm) x 18" (457mm)	Male Luer/female Luer	Black PE
TSD126-324PK	0.100" (2.54mm) x 24" (610mm)	Male Luer/female Luer	Natural PE
TSD126-324BPK	0.100" (2.54mm) x 24" (610mm)	Male Luer/female Luer	Black PE
TSD126-336PK	0.100" (2.54mm) x 36" (914mm)	Male Luer/female Luer	Natural PE
TSD126-336BPK	0.100" (2.54mm) x 36" (914mm)	Male Luer/female Luer	Black PE
TSD126-360BPK	0.100" (2.54mm) x 60" (1524mm)	Male Luer/female Luer	Black PE
TSD126-418PK	0.100" (2.54mm) x 18" (457mm)	Female Luer/female Luer	Natural PE
TSD126-424PK	0.100" (2.54mm) x 24" (610mm)	Female Luer/female Luer	Natural PE
TSD126-436PK	0.100" (2.54mm) x 36" (914mm)	Female Luer/female Luer	Natural PE
TSD126-524PK	0.100" (2.54mm) x 24" (610mm)	Male Luer/male Luer	Natural PE

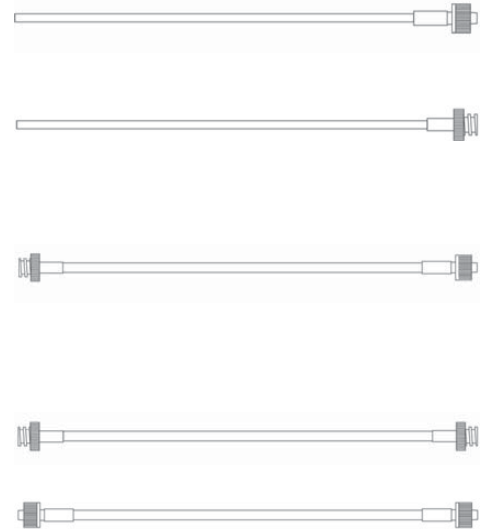

Luer Lock Fittings		
Part Number	Description	Material
TSD931-5	1 Male Luer Lock to 5/16"-28	White Acetal
TSD931-6	2 Male Luer Lock to 1/8" NPT	White Acetal
TSD931-7	3 Male Luer Lock to 1/4" NPT	White Polypropylene
TSD931-8	4 Male Luer Lock to 1/4"-32	White Acetal
TSD931-9	5 Female Luer Lock to 1/4"-32	White Acetal
TSD931-13	6 Female Luer Lock to Hose Barb	White Acetal
TSD931-14	7 Male Luer Lock to 1/4" NPT	Black Polypropylene
TSD931-15	8 Female Luer Lock to 1/4" NPT	Black Nylon/Acetal
TSD931-17	9 Male Luer Lock to Hose Barb	White Acetal
TSD931-28	10 Female Luer Lock to Female Luer Lock	Natural Polypropylene

Luer Lock Fittings

All TSD931 Series fittings are moulded and have good chemical resistance to solvents, acids and resin fluids. The locking end accepts all standard dispensing tips and moulded fitting used on the TSD126 Series hose assemblies. For a complete list, contact your local representative.

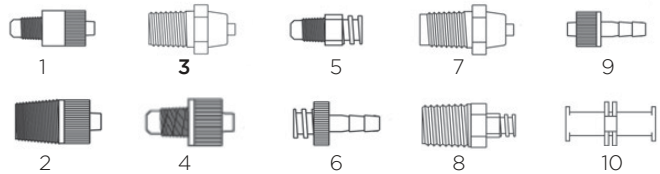

Compression Fittings & Tubes		
Part Number	Description	Material
TSD1003-16	1/8" NPT to 1/4" O.D. tube, 90° fitting	Black Polypropylene
TSD1002-17	1/8" NPT to 3/8" O.D. tube fitting	Black Polypropylene
TSD1002-18	1/8" NPT to 1/4" O.D. tube fitting	Black Polypropylene
TSD1002-38	1/4" NPT to 1/4" O.D. tube fitting	Black Polypropylene
TSD1566-5	1/4" NPT to 3/8" O.D. tube fitting	Black Polypropylene
TSD1099-22	3/8" O.D. x 1/4" I.D. tube	Black Polyethylene
TSD1099-23	3/8" O.D. x 1/4" I.D. tube	Clear Polyethylene
TSD1099-24	1/4" O.D. x 1/8" I.D. tube	Clear Polyethylene
TSD1099-25	1/4" O.D. x 1/8" I.D. tube	Black Polyethylene
TSD1099-45	6mm O.D. x 4mm I.D. tube	Clear Polyethylene
TSD1099-46	6mm O.D. x 4mm I.D. tube	Black Polyethylene

Compression Fittings & Tubes

Compression fittings and tubes provide secure connection and increase fluid flow.



Cartridges & Accessories

These dependable, high quality products are designed for the rigors of manufacturing and have undergone continuous improvement to keep pace with the exacting requirements of this challenging field.

Disposable plastic cartridges and nozzles provide a clean, efficient and low-cost method to meet all types of production requirements. Plungers with a wiper leading edge clean each cartridge thoroughly. Caps and plugs for both ends of the cartridge are available, making the system ideal for prepackaged materials as well as pre-mixed and frozen material handling.

Cartridges

Cartridges are available in 2 1/2, 6, 8, 12, and 20 ounce as well as 1/10 gallon capacities. Each size can be used with hand or bench mounted air powered dispensing tools or manual dispensing tools. Cartridges are moulded in either standard or low density polyethylene. Custom colors are available. Sold in bulk packages.

Cartridges			
Part Number	Description	Length Inches/mm	Diameter Inches/mm
TS25C-500	2.5 oz. (74ml) Natural HDPE	4.00/101.6	1.59/40.4
TS25C-LD-500	2.5 oz. (74ml) Natural LDPE	4.00/101.6	1.59/40.4
TS60C-500	6 oz. (177ml) Natural HDPE	7.11/180.6	1.59/40.4
TS60C-BLACK-500	6 oz. (177ml) Black HDPE	7.11/180.6	1.59/40.4
TS60C-LD-500	6 oz. (177ml) Natural LDPE	7.11/180.6	1.59/40.4
TS80C-250	8 oz. (237ml) Natural HDPE	8.92/226.6	1.59/40.4
TS80C-LD-250	8 oz. (237ml) Natural LDPE	8.92/226.6	1.59/40.4
TS120C-250	12 oz. (355ml) Natural HDPE	12.34/313.4	1.59/40.4
TS120C-BLACK-250	12 oz. (355ml) Black HDPE	12.34/313.4	1.59/40.4
TS120C-LD-250	12 oz. (355ml) Natural LDPE	12.34/313.4	1.59/40.4
TS110C-250	1/10 Gallon (325ml) Natural HDPE	8.99/228.3	1.85/47.0
TS110C-LD-250	1/10 Gallon (325ml) Natural LDPE	8.99/228.3	1.85/47.0
TS20C-100	20 oz. (591ml) Natural HDPE	10.3/254.8	2.57/65.3
TS20C-BLACK-100	20 oz. (591ml) Black HDPE	10.3/254.8	2.57/65.3
Plungers			
Wiper Plungers incorporate a modified or extended front wiper edge. Sold in bulk packages.			
Part Number	Description		
TS1P-SR-1000	2.5, 6, 8, 12 oz., Blue Wiper LDPE		
TS1PB-SR-1000	2.5, 6, 8, 12 oz., Black Wiper LDPE		
TS1WP-1000	2.5, 6, 8, 12 oz., Natural Extended Wiper LDPE		
TS3WP-MD-1000	2.5, 6, 8, 12 oz., Natural Reduced Wiper MDPE		
TS2PW-1000	1/10 Gallon White Extended Wiper LDPE with EVA		
TS2P-BLACK-1000	1/10 Gallon Black Wiper LDPE		
TS2OP-100	20 oz. White Wiper MDPE		
TS2OPLD-100	20 oz. Natural Wiper LDPE		
Caps			
Top and bottom Caps provide a choice of methods to seal the neck and base of the cartridge. Sold in bulk packages.			
Part Number	Description		
TS2C-1000	2.5, 6, 8, 12 oz. Red LDPE Flange Cap		
TS4C-1000	1/10 Gallon Red LDPE Flange Cap		
TS6C-1000	20 oz. Red LDPE Flange Cap		
TS3P-1000	Threaded Tri Seal Red PE Cap		
TS4P-1000	Threaded Square Red PE Cap		
TS5P-1000	Snap On Tri Seal Red PE Cap		
TS6P-BLACK-1000	Threaded Black PE Cap		
TS6P-RED-1000	Threaded Red PE Cap		
TS9X-1000	Push On Red PE Cap		
LD = Low Density, HD = High Density, EVA = Ethylene Vinyl Acetate, MD = Medium Density, PE = Polyethylene			

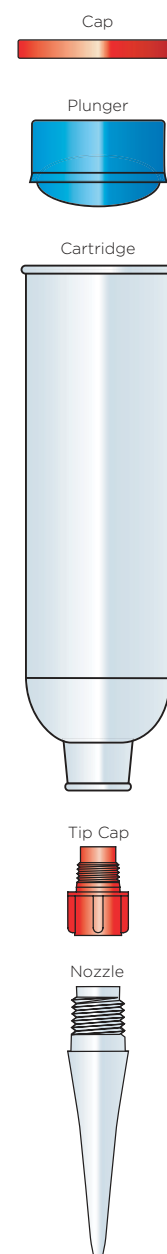

Disposable Nozzles & Tip Adapters

Disposable Nozzles and Dispensing Tip Adapters

Nozzles and dispensing tip adapters provide a wide range of application capabilities. Standard nozzles may be cut back to increase orifice size.

Dispensing Tip Adapters

These tip adapters have standard 1/4" NPT male threads on one end to fit all Techcon Systems cartridges or equivalent and standard male Luer lock threads on opposite side to fit all Luer lock dispensing tips.

Part Number	Description
TSD931-7	Dispensing Tip Adapter White Polypropylene
TSD931-14	Dispensing Tip Adapter Black Polypropylene
918-006-000	Dispensing Tip Adapter Metal



Bent Nozzles

Below is the list of standard bent nozzles. Special bent nozzles available upon request. Part numbers below are sold in bulk package of 1000.

Part Number	Description
TS416-HO-LD-B30/1-1000	Bent 30° at 1" (25.4mm)
TS416-HO-LD-B30/2-1000	Bent 30° at 2" (50.8mm)
TS416-HO-LD-B40/1-1000	Bent 40° at 1" (25.4mm)
TS418-HO-LD-B30/1-1000	Bent 30° at 1" (25.4mm)
TS618-HO-LD-B30/2-1000	Bent 30° at 2" (50.8mm)

Standard Nozzles

Standard nozzles are precision moulded from natural polyethylene and have 1/4" NPT male threads to fit all Techcon cartridges or equivalent. Color nozzles are available upon request. Part numbers below are sold in bulk package of 1000.

Part Number	Description
TS216-1000	2" (50.8mm) x 1/16" (1.6mm), HDPE
TS218-1000	2" (50.8mm) x 1/8" (3.2mm), HDPE
TS218-LD-1000	2" (50.8mm) x 1/8" (3.2mm), LDPE
TS416-HO-HD-1000	4" (101.6mm) x 1/16" (1.6mm), HDPE
TS416-HO-LD-1000	4" (101.6mm) x 1/16" (1.6mm), LDPE
TS418-HO-LD-1000	4" (101.6mm) x 1/8" (3.2mm), LDPE
TS432-HO-HD-1000	4" (101.6mm) x 1/32" (0.8mm), HDPE
TS432-HO-LD-1000	4" (101.6mm) x 1/32" (0.8mm), LDPE
TS490-HO-LD-1000	4" (101.6mm) x 3/32" (2.4mm), LDPE
TS616-HO-LD-1000	6" (152.4mm) x 1/16" (1.6mm), LDPE
TS618-HO-LD-1000	6" (152.4mm) x 1/8" (3.2mm), LDPE

Specialty Nozzles

Specialty nozzles are precision moulded from natural polyethylene and have 1/4" NPT male threads to fit all Techcon cartridges or equivalent. Part numbers below are sold in bulk package of 1000.

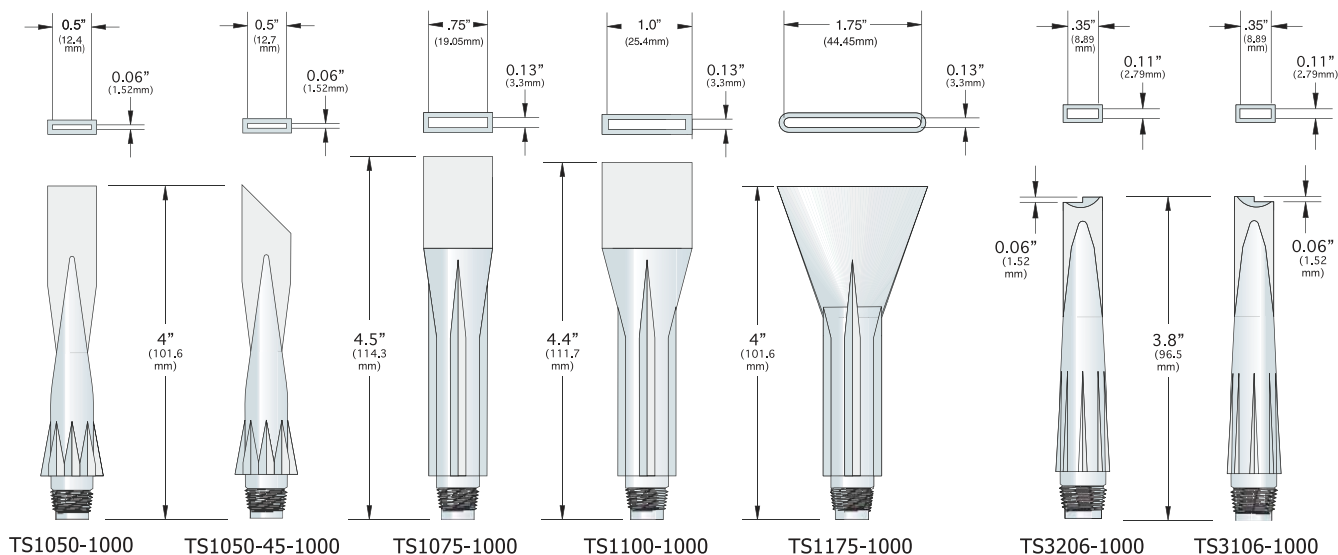

G Series

Dispensing Guns and Components



G Series Retainer Cap

The G Series retainer cap provides a leak-proof connection between the dispenser and G Series retainers. Shipped complete with air hose assembly, and can withstand up to 70 psi (4.8 bar) pressure.



Part Number	Description
918-000-036	G Series Retainer Cap

G Series Retainer

The G Series retainers provide up to 100 psi (6.9 bar) air pressure.



Part Number	Size
110-2	1/10 gal. (325ml)
101-25R	2.5 oz. (74ml)
101-60R	6 oz. (177ml)
101-120R	12 oz. (355ml)
101-20R*	20 oz. (591ml)
101-20A	20 oz. Adapter (591ml)

*101-20A Adapter is required for 20 oz.

G Series Dispensing Guns and Components

Techcon Systems G Series guns and components are designed to accommodate standard 1/10 gallon cartridges, such as Techcon's TS110C. Techcon also provides metal retainers that adapt the G Series handle assemblies for use with the smaller diameter cartridges. A 20 oz. retainer with adapter is available to accommodate the 20 oz. cartridge.

G Series Gun Assemblies

This pneumatic pistol grip G Series gun provides infinite control of line or dot dispensing and can withstand up to 100 psi (6.9 bar) pressure. Shipped complete with a 10-foot air hose.



Part Number	Size	Handle	Retainer
G-110	1/10 gal. (325ml)	110-1-10	110-2
G110-25	2.5 oz. (74ml)	110-1-10	101-25R
G110-60	6 oz. (177ml)	110-1-10	101-60R
G110-120	12 oz. (355ml)	110-1-10	101-120R
G110-20*	20 oz. (591ml)	110-1-10	101-20R

*101-20A Adapter included.

TS910 Tube Dispense Gun

The TS910 gun is ideal for dispensing RTV silicones, grease or other material that contain in collapsible tube. Shipped complete with 5 foot (1.5 meters) air hose, quick connect fitting, nozzle and locking nut.



Part Number	Size
TS910	3 to 5 fluid oz. (89 -148ml)

TS Series Dispensing Guns and Components

TS Series dispensing guns and components are designed to accommodate Techcon Systems extensive line of cartridges and Techkits.

TS2560 Series Applicator Guns Lightweight Cartridge Applicator

These palm and pistol grip applicator guns allow for the processing of Techcon and standard sealant cartridges with ease. The TS2560 series dispensing gun is ideal for dispensing silicones, grease or other materials that come in standard cartridges.

A unique, light-weight, adjustable retainer fits cartridge sizes of 2.5oz., 6oz. & 8oz.

With a maximum working pressure of 5.5 bar (80psi), the guns are ideally suited for a multitude of aerospace and other industrial applications.



Part Number	Handle Style
TS2560-PG	Palm Grip
TS2560-HG	Pistol Grip

TS Retainers

The TS Series retainers are durable, lightweight and can withstand up to 100 psi (6.9 bar) pressure.

Part Number	Size
918-030-000	2.5 oz. (74ml)
918-031-000	6 oz. (177ml)
918-034-000	8 oz. (237ml)
918-032-000	12 oz. (355ml)

TS16 Manual Gun Assemblies

The lightweight TS16 Series manual gun assembly is ideal for field applications where compressed air is unavailable.



Gun	Size	Handle	Retainer
TS16-25	2.5 oz. (74ml)	TS16	918-030-000
TS16-60	6 oz. (177ml)	TS16	918-031-000
TS16-80	8 oz. (237ml)	TS16-2	918-034-000
TS16-120	12 oz. (355ml)	TS16-2	918-032-000



Key Features

- Easy to assemble & operate
- Adjustable retainer to fit 2.5oz., 6oz. & 8oz. cartridges
- Light-weight
- Pistol version features adjustable air regulator
- Compatible with all aerospace sealant manufacturers

TS950 Sealant Gun

The TS950 is a versatile, pneumatic sealant gun designed to accommodate all TS Series retainers. Complete assembly includes palm grip gun with pistol grip handle attached. Shipped without air hose, the 1000-12 ten-foot hose assembly can be ordered separately.



Pistol Grip Sealant Gun	Size	Palm Grip Assembly	Pistol Grip Handle	Retainer
TS950-25-HA	2.5 oz. (74ml)	TS950-75	TS950-3	918-030-000
TS950-60-HA	6 oz. (177ml)	TS950-75	TS950-3	918-031-000
TS950-80-HA	8 oz. (237ml)	TS950-75	TS950-3	918-034-000
TS950-120-HA	12 oz. (355ml)	TS950-75	TS950-3	918-032-000

TS Retainer Cap

The TS Series retainer cap provides a leak-proof connection between the dispenser and TS Series retainers. Quick connector and air hose assembly are available separately and can withstand up to 100 psi (6.9 bar) pressure.



Part Number	Description
918-001-004	TS Series Retainer Cap
918-000-002	Air Hose Assembly
534	Connector with Shut-off
534A	Connector without Shut-off

TS6500 Series

Techkit Cartridge Mixers



TS6500 - Cartridge Mixer

Specifications	
Size	15.7"W x 21.2"D x 40.6"H 398mm x 538mm x 1032mm
Weight	80 lb. (36kg)
Internal Voltage	120-230VAC, 50-60 Hz, 2 Amp
Motor Speed	139 RPM
Air Inlet	80 psi (5.5 Bar) Min.
Stroke Speed	33 Strokes/minute (fully extended)
Meets or exceeds	CE, cTUV-us
Warranty	1 year

Key Features

- Universal power supply for worldwide use
- Automatic fluid level sensing device for all kit sizes- No need to set stroke length
- Automatically injects hardener into resin to provide uniform mixed material
- Robust, high torque motor to handle high viscosity material
- Safety features include safety enclosure, emergency stop button and two-hand start
- User programmable manual and automatic mixing cycle settings
- 10 programmable memories for storing and recalling most frequently used mix cycle
- Quick and easy to replace cartridge holder and plunger - No tool needed
- User friendly firmware for easy setup
- Robust and sturdy platform for heavy industrial used
- RoHS, WEEE compliance, CE certified

TS6500 Series

Techkit Cartridge Mixers

The TS6500 Series cartridge mixer provides complete automatic mixing of two-component material filled in a cartridge kit. The feature rich TS6500 Series accommodates all standard size cartridge kits ranging from 2.5 oz. (74ml) to 20 oz. (591ml) and is immediately usable anywhere in the world with its accompanying tools, accessories and universal power supply.

Techkits

Two Component Cartridge Packaging and Mixing Kits

The Techkit is a compact and simple method of packaging two or three component resin systems into a 2 1/2, 6, 8, 20 ounce or 1/10 gallon cartridge. The kit mechanically separates the base and hardener until they are ready to be used. An internal mixing head provides a thorough blend for all types of compounds. When the job has been completed, the entire package is disposed of: no clean up or physical contact with the resin. Reliability is increased with accurate compound ratios, complete mixing and proper application techniques.

Three types of kits are available:

Barrier Type

For compounds with a Minimum demand of 23ml Hardener the catalyst and base are separated by an aluminum barrier formed over the mixing head



Injection Type

For compounds with a Maximum demand of 12.5ml or less the catalyst is contained inside the valved mixing rod while the base is in the cartridge.

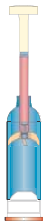

Barrier/Injection Type

For three component compounds, components of both Injection and Barrier are combined.



Part number	Description
TS6500CIM-6	Cartridge Mixer for 2.5 (74ml), 6 oz. (177ml), 8 oz. (237ml) kit
TS6500CIM-20	Cartridge Mixer for 20 oz. (591ml) kit
CK6500-6	Conversion Kit for 2.5, 6, 8 oz. kit
CK6500-10	Conversion kit for 1/10 gal kit
CK6500-20	Conversion kit for 20 oz. kit

Techkit Components

Complete Techkits

Part Number	Size	Type	Cartridge	Plunger	Cap	Mix Head	Rod	Ram Rod
110-80	1/10 gal. (325ml)	Injection	TS110C	TS2PW	TS4C	110-340	810-100A	600-080
110-81	1/10 gal. (325ml)	Barrier	TS110C	TS2PW	TS4C	110-350	800-100	
110-81T	1/10 gal. (325ml)	Taped Barrier	TS110C	TS2PW	TS4C	110-350	800-100	
250-60	2 1/2 oz. (74ml)	Injection	TS25C	TS1WP	TS2C	600-200	610-100A	600-080
250-61	2 1/2 oz. (74ml)	Barrier	TS25C	TS1WP	TS2C	600-310	600-100	
250-61T	2 1/2 oz. (74ml)	Taped Barrier	TS25C	TS1WP	TS2C	600-310	610-100	
250-80	2 1/2 oz. (74ml)	Injection	TS25C	TS1WP	TS2C	600-200	810-100A	600-080
250-81	2 1/2 oz. (74ml)	Barrier	TS25C	TS1WP	TS2C	600-310	800-100	
250-81T	2 1/2 oz. (74ml)	Taped Barrier	TS25C	TS1WP	TS2C	600-310	800-100	
600-60	6 oz. (177ml)	Injection	TS60C	TS1WP	TS2C	600-200	610-100A	600-080
600-61	6 oz. (177ml)	Barrier	TS60C	TS1WP	TS2C	600-310	600-100	
600-61T	6 oz. (177ml)	Taped Barrier	TS60C	TS1WP	TS2C	600-310	600-100	
600-80	6 oz. (177ml)	Injection	TS60C	TS1WP	TS2C	600-200	810-100A	600-080
600-81	6 oz. (177ml)	Barrier	TS60C	TS1WP	TS2C	600-310	800-100	
600-81T	6 oz. (177ml)	Taped Barrier	TS60C	TS1WP	TS2C	600-310	800-100	
800-80	8 oz. (237ml)	Injection	TS80C	TS1WP	TS2C	600-200	810-100A	600-080
800-81	8 oz. (237ml)	Barrier	TS80C	TS1WP	TS2C	600-310	800-100	
800-81T	8 oz. (237ml)	Taped Barrier	TS80C	TS1WP	TS2C	600-310	800-100	
200-80	20 oz. (591ml)	Injection	TS20C	TS20P	TS6C	600-360	810-100A	600-080
200-81	20 oz. (591ml)	Barrier	TS20C	TS20P	TS6C	600-370	800-100	
200-81T	20 oz. (591ml)	Taped Barrier	TS20C	TS20P	TS6C	600-370	800-100	



Mix Heads

Part Number	Description
110-340	1/10 gal. (325ml) Mix Head
110-350	1/10 gal. (325ml) Foiled Mix Head
600-200	Open Mix Head
600-300	Wheel Mix Head
600-310	Foiled Wheel Mix Head
600-320	Half Closed Circle Mix Head
600-330	Foiled Half Closed Circle Mix Head
600-360	20 oz. (591ml) Wheel Mix Head
600-370	20 oz. (591ml) Foiled Wheel Mix Head
600-380	20 oz. (591ml) Spoked Wheel Mix Head

Sealant Smoothing and Removal Tools

Techcon Systems plastic sealant tools are ideal for spreading, smoothing and removing sealants or adhesives. Approved for use in aerospace industry, these tools are designed to prevent damage to delicate substrates. Spatulas made from Nylon. Smoothing tool made from Celcon®.

Part Number	Description
1275-000-001	4 Spatula, Large
1275-000-002	2 Spatula, Medium
1275-000-003	2 Spatula, Small
TS1275-KP	1 Spatula Kit
TS1275-4	5 Smoothing tool, Red Celcon®

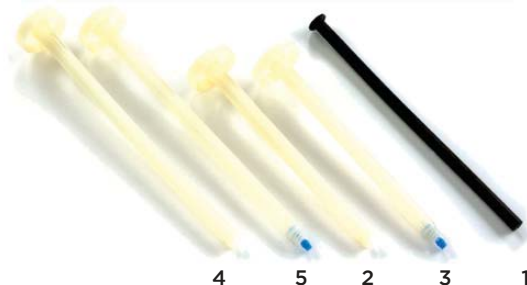

Rods

Part Number	Description
600-080	1 8" (203.2mm) Ram Rod
600-100	2 6" (152.4mm) Plugged Rod
610-100A	3 6" (152.4mm) Valved Rod with Piston
800-100	4 8" (203.2mm) Plugged Rod
810-100A	5 8" (203.2mm) Valved Rod with Piston

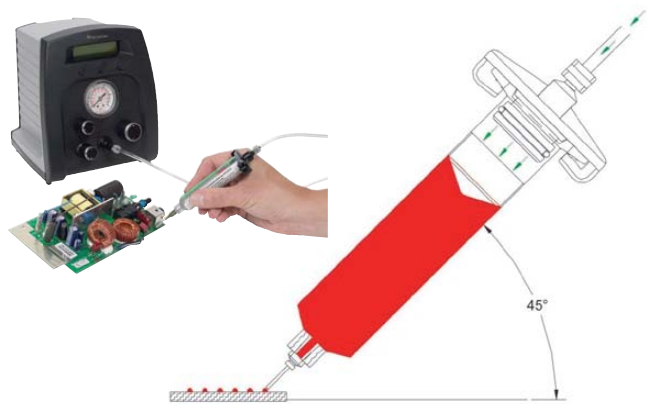

Tutorial

Time-Pressure Dispensing

Time pressure dispensing is the most common dispensing method used today. Its popularity stems from the need for process control and the fact that it is possible to dispense from disposable containers without the need for cleaning.

Our time-pressure dispensers deliver a measured amount of air pressure, for a measured amount of time, to a pre-filled syringe barrel. This controlled shot of air pressure forces material out of the delivery end of the barrel, through a dispensing tip and out to the application surface.

Basic Dispensing Guidelines

- **Small Shot Size** = small dispensing tip, low fluid pressure, short dispense time
- **Large Shot Size** = larger dispensing tip, higher fluid pressure, longer dispense time
- **Low Viscosity Fluid** = small dispensing tip, low pressure, time as required
- **High Viscosity Fluid** = larger dispensing tip (tapered dispensing tip recommended), high pressure, time as required
- Position syringe barrel at 45° angle
- Position the dispensing tip close to the work surface then activate the dispense cycle and keep the syringe barrel in the same position until the cycle is completed
- If vacuum "suck-back" is needed, use only enough vacuum to draw back fluid into the dispense tip. Excessive vacuum could draw air into the fluid and also could draw fluid into the dispenser.

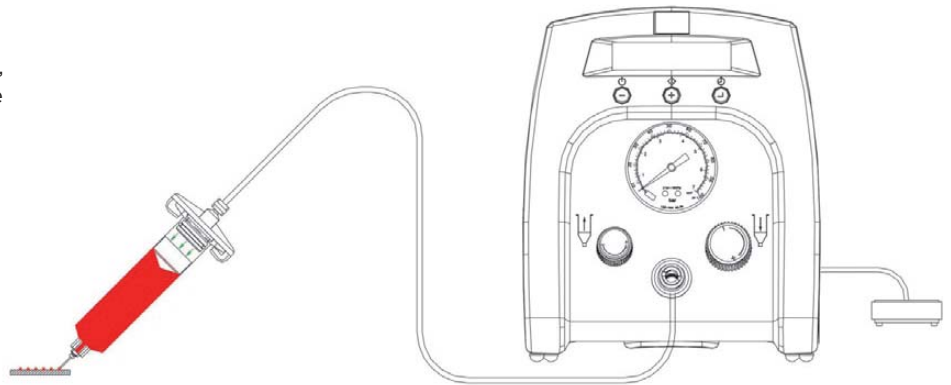

Viscosity Chart

Material	Viscosity (Centipoise)
Water	1
Milk	3
Castor Oil	1000
Maple Syrup	5000
Honey	10000
Chocolate Syrup	25000
Ketchup	50000
Sour Cream	100000
Peanut Butter	250000
Shortening	1200000

Shot Size Chart

Dot Diameter	Dot Volume	Dot Size (actual)
0.010" (0.25mm)	0.0000043 cc	•
0.020" (0.51mm)	0.00003 cc	•
0.030" (0.76mm)	0.0001 cc	•
0.040" (1.02mm)	0.0003 cc	•
0.050" (1.27mm)	0.0005 cc	•
0.060" (1.52mm)	0.0009 cc	•
0.070" (1.78mm)	0.0015 cc	•
0.080" (2.03mm)	0.0022 cc	•
0.090" (2.29mm)	0.0031 cc	•
0.100" (2.54mm)	0.0043 cc	•

Factors Affecting Dispensing

- **Pressure:** Increasing fluid pressure will increase dot size and vice versa
- **Time:** Increasing dispense time will increase dot size and vice versa
- **Dispensing Tip Size:** Larger inside diameter (orifice) needle results in bigger dot size

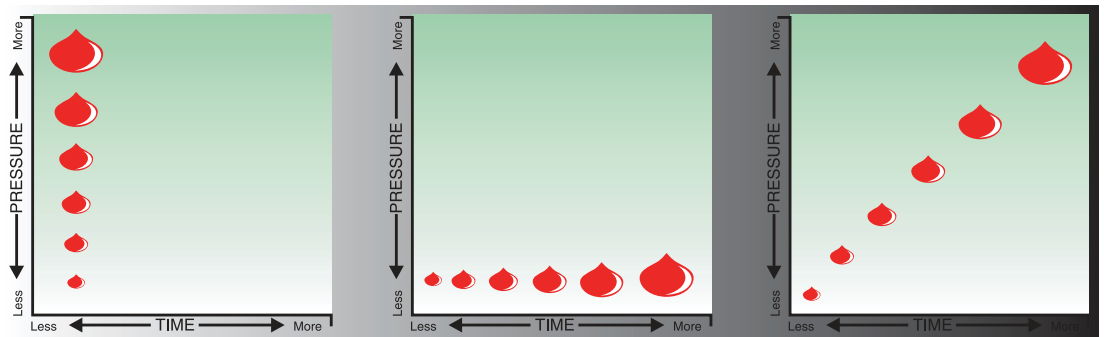

Valve Diagrams

Various Valve Diagrams

TS5620
Diaphragm Valve

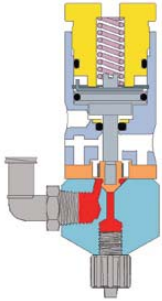

TS5540
Spray Valve

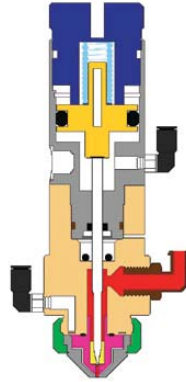

TS5322
Mini Spool Valve

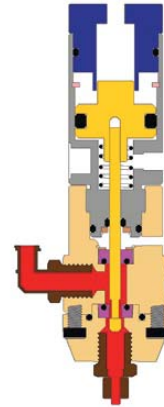

TS5000DMP-DCX
Rotary Valve

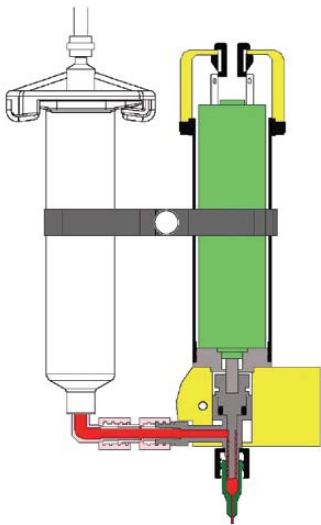

TS5420
Needle Valve

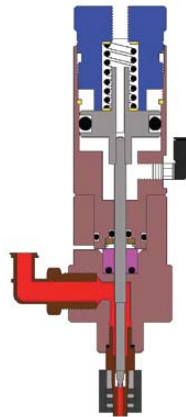

TS5440
Microshot Needle Valve

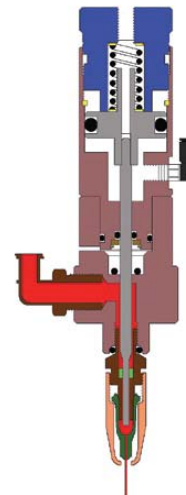

TS941
High Pressure Spool Valve

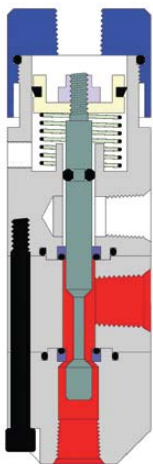

TS7000-DCX
IMP Rotary Valve

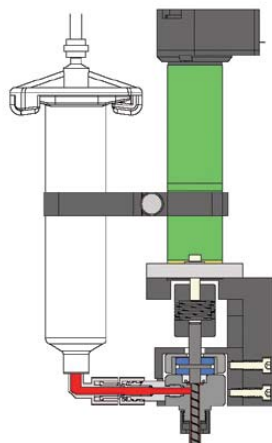

TS8100
PC Pump

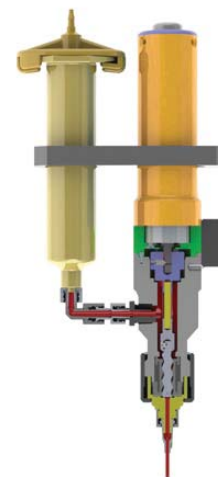



Corporate Headquarters (United States)
OK International/ Techcon Headquarters

10800 Valley View Street
Cypress, CA 90630
Tel: 1-714-230-2398
Fax: 1-714-230-2393
Email: oemorders@okinternational.com

European Corporate Office
OK International/ Techcon

Eagle Close, Chandler's Ford
Hampshire, SO53 4NF, United Kingdom
Tel: English +44 2380 489 100
Tel: Français: +33 176 710 403
Tel: Deutsch: +49 (0)3222 109 1900
Email: Europe-Orders@okinternational.com

China Corporate Office
OK International/ Techcon

4th floor East, The Electronic Building
Yanxiang Industrial Zone
High Tech Road, Guangming New District
Shenzhen, P.R.C
Tel: +86-755-2327 6366
Fax: +86-755-2329 5492
Email: china@okinternational.com